

PS16

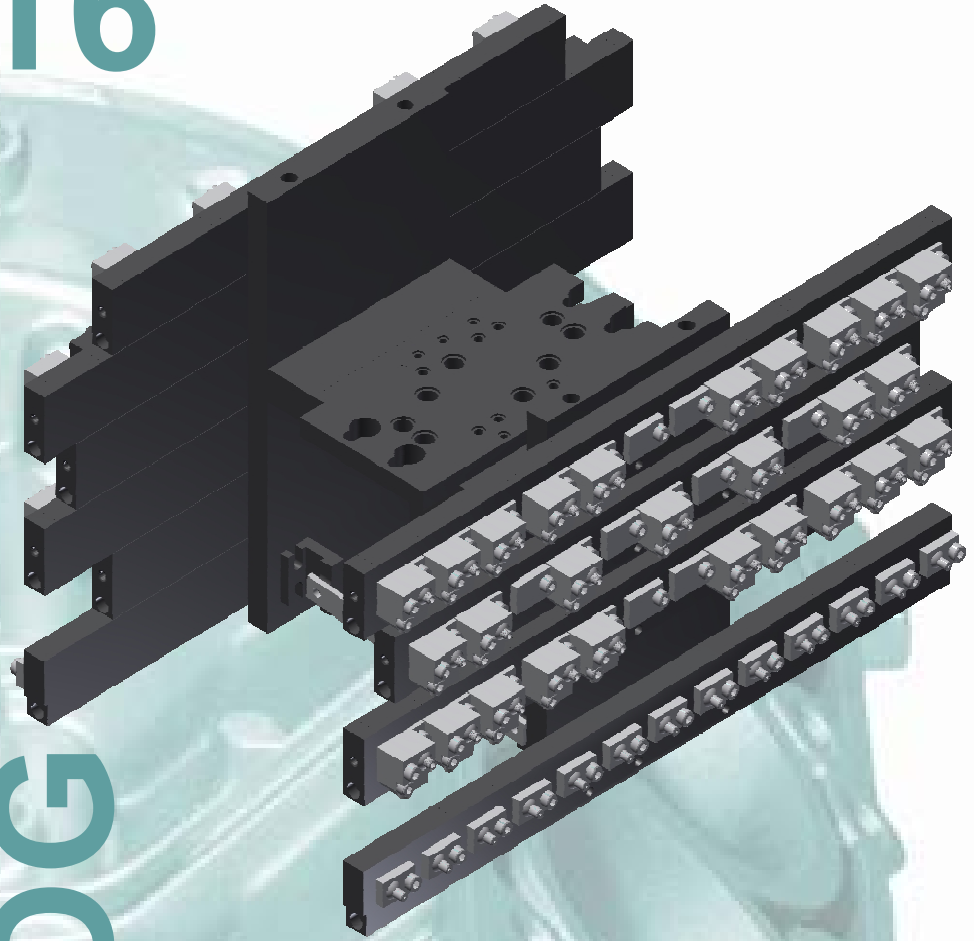

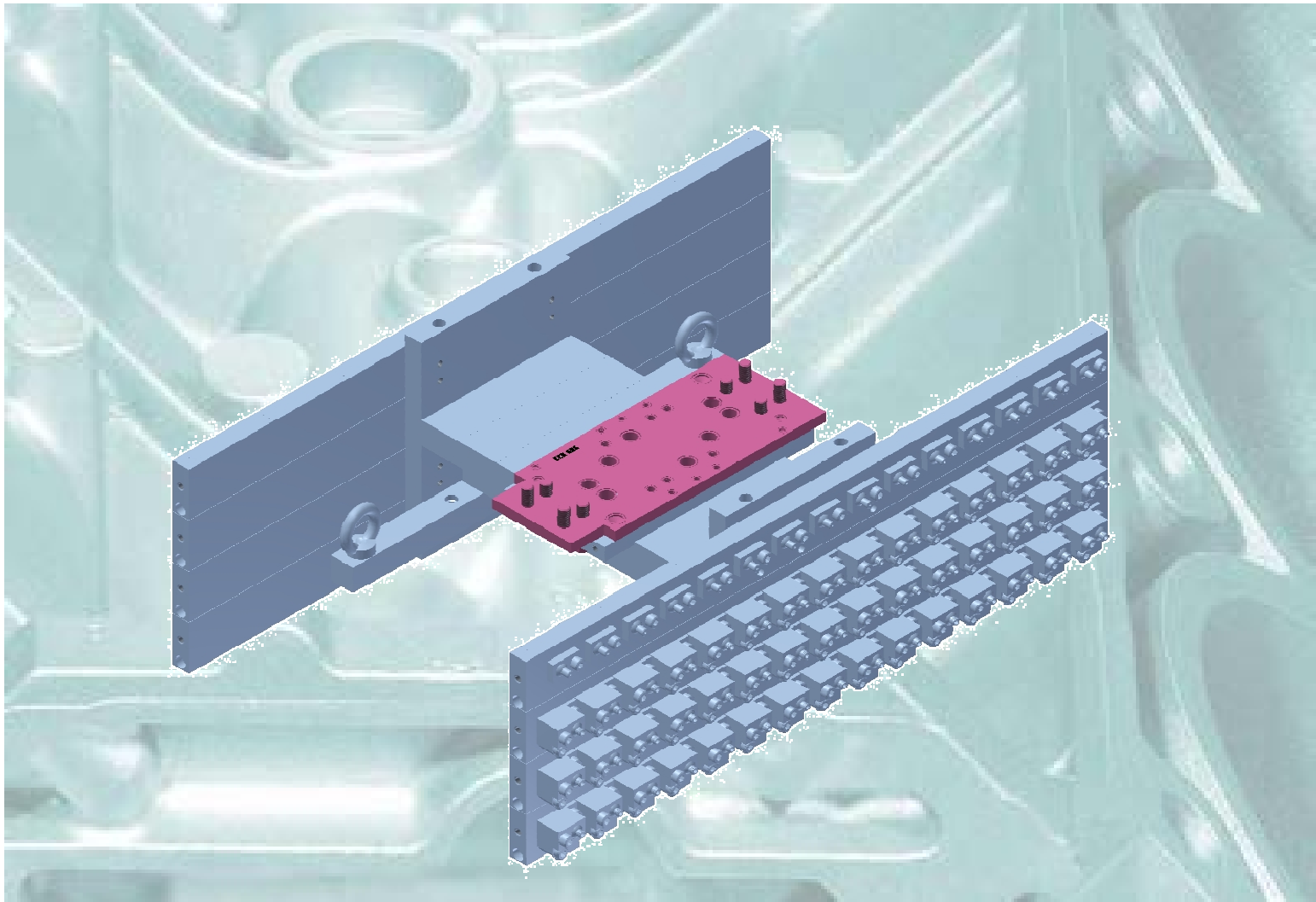









KATALOG CATALOG







Artikelgruppe 0 prod.group 0



Artikelgruppe 0
 prod.group 0

<p>000.1 Artikelnr./ partno.303969</p>		
<p>Zwischenadapter PS16-6 an PSM2, komplett intermediate adapter PS16-6 on PSM2</p>		
<p>000.2 Artikelnr./ partno.303983</p>		
<p>Zwischenadapter PS16-4/PSM2 VL2004/PSM2, komplett intermediate adapter PS16-4/PSM2 VL2004/PSM2, complete</p>		
<p>000.3 Artikelnr./ partno.306974</p>		
<p>Spezialverteilerplatte VL2004 (4-Kr.) an PSM3, komplett Special-distributor plate PSM3 to PS16-4 / VL2004</p>		
<p>000.4 Artikelnr./ partno.307111</p>		
<p>Zwischenadapter PS16/PSM224 an PSM2 komplett Intermediate adaptor PS16/PSM224 to PSM2</p>		
<p>000.5 Artikelnr./ partno.307242</p>		
<p>Zwischenadapter PS16-4 an PSM336/PSM3, komplett intermediate adapter PS16/PSM2</p>		







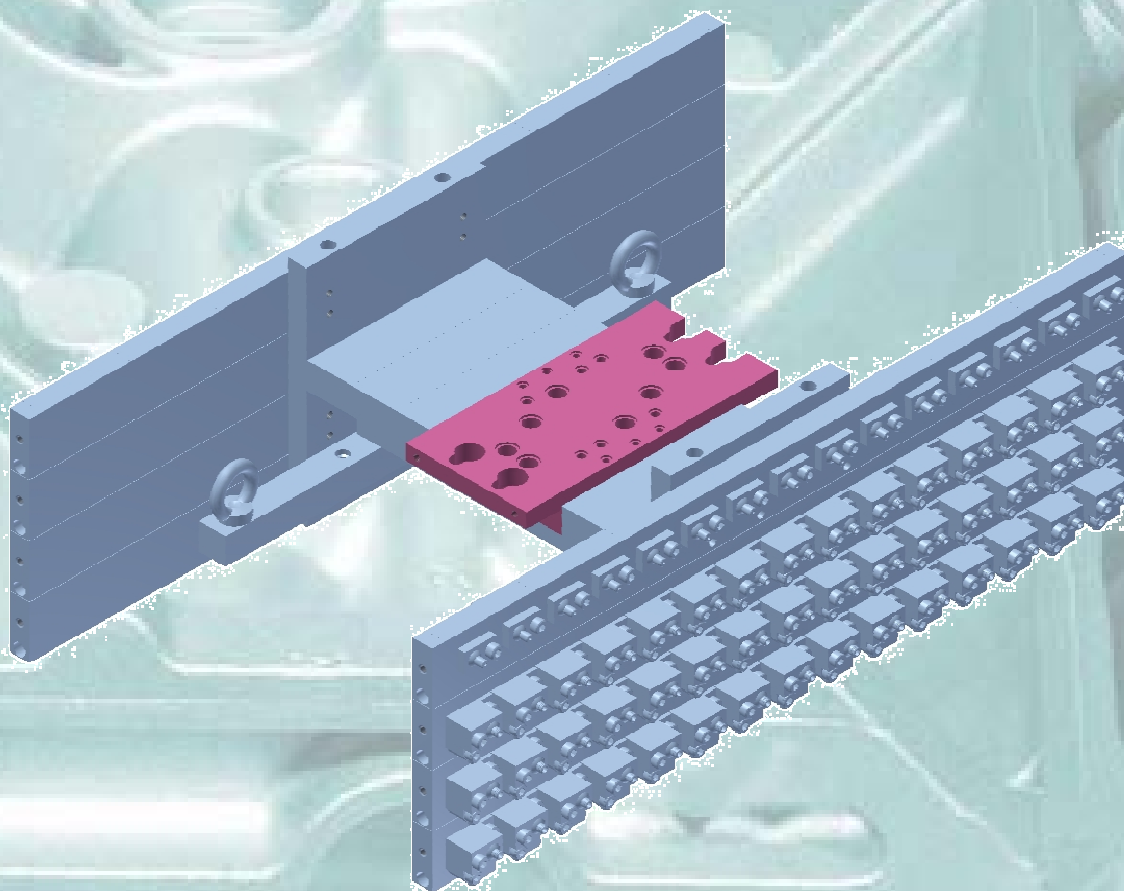



Artikelgruppe 0
 prod.group 0

<p>000.6 Artikelnr./ partno.309822</p>		
<p>Zwischenplatte 8 zu 6Kreis für PSM4 mit 6-Kreis -SPW Intermediateplate 8 to 6 for PSM4 with 6-circuit tool</p>		
<p>000.7 Artikelnr./ partno.319894</p>		
<p>Spezialverteilerplatte VL2004 (4-Kr.) an PSM3+1, komplett Special-distributor plate PSM3+1 to PS16-4 / VL2004</p>		
<p>000.8 Artikelnr./ partno.325679</p>		
<p>Zwischenadapter Wollin an IDRA PS16-6 (6-Kr.) an LS45 (6-Kr.), komplett Intermediate adapter PS16-PSM3 to IDRA LS45 6-circuit, compl.</p>		





Artikelgruppe 10 prod.group 10







Artikelgruppe 10
 prod.group 10

010.1 Artikelnr./ partno.140921		
Adapter PS16-6/SM-4Kreis/PSM-4Kreis komplett Adaptor PS16 - SM 4 circuit		
010.2 Artikelnr./ partno.143511		
Adapter PS16-6/PSM324/PSM336/PSM436 komplett Adaptor PS16-6/PSM324/PSM336/PSM436 complete		
010.3 Artikelnr./ partno.153320		
Adapter PS16/SM-2Kreis komplett Adaptor PS16/SM2 circuit complete		
010.4 Artikelnr./ partno.207696		
Adapter PS16-8/PSM448 komplett Adaptor PS16-8/PSM448		
010.5 Artikelnr./ partno.215947		
Adapter PS16-6/PSM224 komplett Adaptor PS16-6/PSM224		

Artikelgruppe 10
 prod.group 10

<p>010.6 Artikelnr./ partno.300248</p> <p>Adapter PS16-8/PSM448 bewegliche Seite 8 Kreise</p> <p>Adaptor PS16-8/PSM448 moveable side - 8 circuits</p>		
<p>010.7 Artikelnr./ partno.303011</p> <p>Adapter PS16-6/PSM324-6/PSM336/PSM436/PSM3,6 komplett</p> <p>Adaptor, narrow PS16-6, complete</p>		
<p>010.8 Artikelnr./ partno.303862</p> <p>Adapter PS16/PSM2 komplett</p> <p>Adaptor PS16/PSM2 complete</p>		
<p>010.9 Artikelnr./ partno.304071</p> <p>Adapter B3/F2 PS16/PSM2 bew. 3 Kreise / fest 2 Kreise</p> <p>Adaptor B3/F2 PS16/PSM2</p>		
<p>010.10 Artikelnr./ partno.305147</p> <p>Adapter PS16/PSM1 komplett</p> <p>Adaptor PS16-6/PSM1 complete</p>		







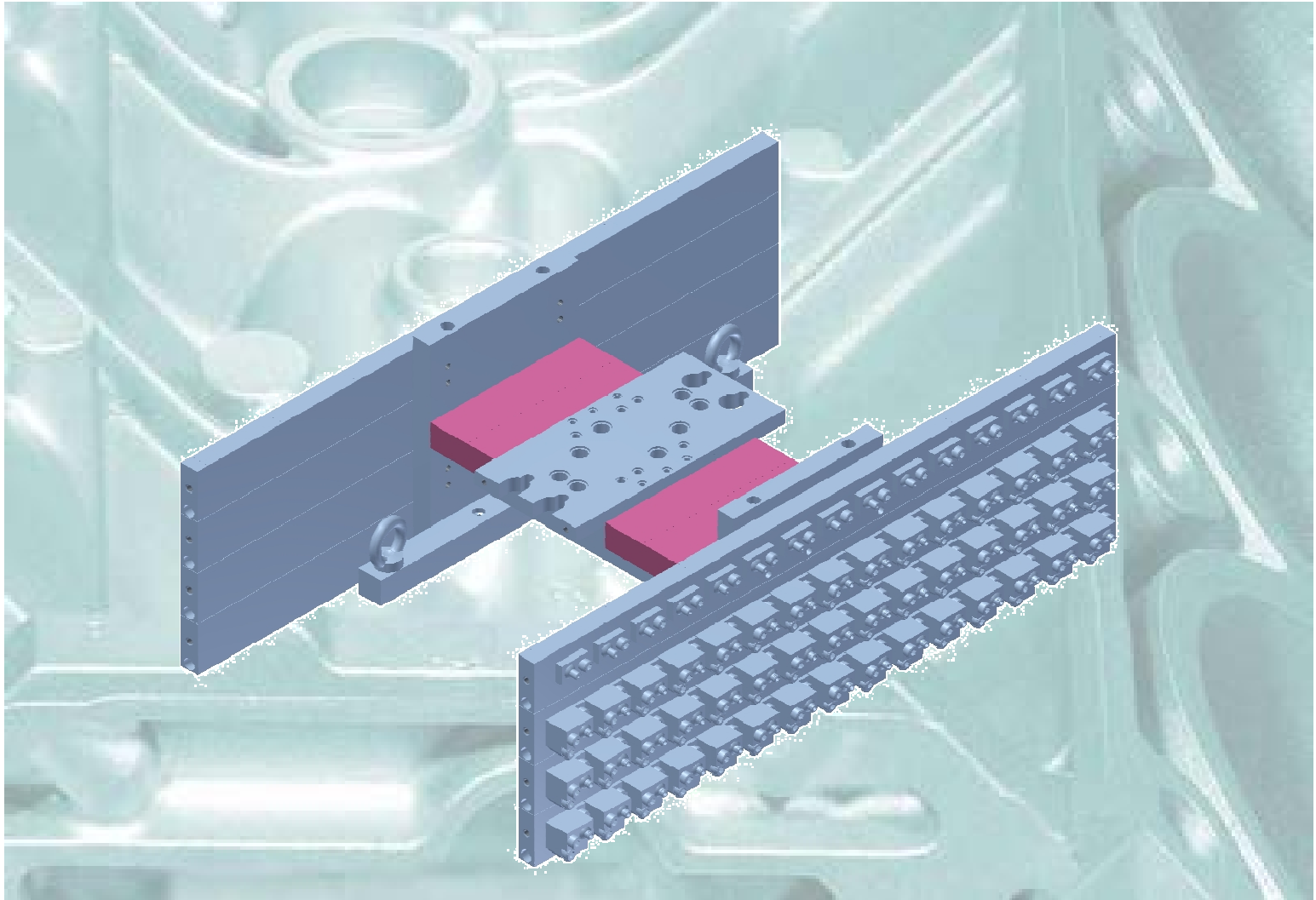



Artikelgruppe 10
prod.group 10

010.11 Artikelnr./ partno.307006		
Adapter PS16/PSM2, schmal komplett Adaptor PS16/PSM2, narrow complete		
010.12 Artikelnr./ partno.801611		
Adapter PS16/PSM2 für 6-Kreise, K1-K5 und K2-K6 verbunden, komplett Adaptor PS16/PSM2 complete		









Artikelgruppe 11 prod.group 11

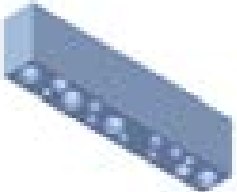



Artikelgruppe 11
 prod.group 11

<p>011.1 Artikelnr./ partno.143529</p> <p>Adaptermodul 50mm PS16/PS16C-6, komplett</p> <p>Adaptor module 50mm PS16/PS16C-6, complete</p>		
<p>011.2 Artikelnr./ partno.143933</p> <p>Adaptermodul 25mm PS16/PS16C-6, komplett</p> <p>Adaptor module 25mm PS16/PS16C-6, complete</p>		
<p>011.3 Artikelnr./ partno.207712</p> <p>Adaptermodul 50mm PS16/PS16C-8, komplett</p> <p>Adaptor module 50mm PS16/PS16C-8, complete</p>		
<p>011.4 Artikelnr./ partno.207746</p> <p>Adaptermodul 25mm PS16/PS16C-8, komplett</p> <p>Adaptor module 25mm PS16/PS16C-8, complete</p>		
<p>011.5 Artikelnr./ partno.224246</p> <p>Adaptermodul 25mm, 90° gedreht PS16/PS16C-6, komplett</p> <p>Adaptor module 25mm, 90° turned PS16/PS16C-6, complete</p>		

Artikelgruppe 11
 prod.group 11

<p>011.6 Artikelnr./ partno.300591</p> <p>Adaptermodul 50mm (>300) PS16/PS16C-6, kompl. für Adaptermodullg.>300mm</p> <p>Adaptor module 50mm (>300) PS16/PS16C-6, complete, for longer than 300mm</p>		
<p>011.7 Artikelnr./ partno.305557</p> <p>Adaptermodulabzweigung PS16/PS16C-8, komplett</p> <p>Adaptor module junction PS16/PS16C-8, complete</p>		
<p>011.8 Artikelnr./ partno.305753</p> <p>Adapterschliessleiste PS16-6, komplett</p> <p>Cover for adaptor PS16-6, complete</p>		
<p>011.9 Artikelnr./ partno.800174</p> <p>Adaptermodul 50mm, 90° gedreht PS16/PS16C-8, komplett</p> <p>Adaptor module 50mm, turned 90° PS16/PS16C-8, complete</p>		
<p>011.10 Artikelnr./ partno.801372</p> <p>Adaptermodul 50mm (>300) PS16/PS16C-8, kompl. für Adaptermodullg.>300mm</p> <p>Adaptor module 50mm (>300) PS16/PS16C-8, complete, for longer than 300mm</p>		







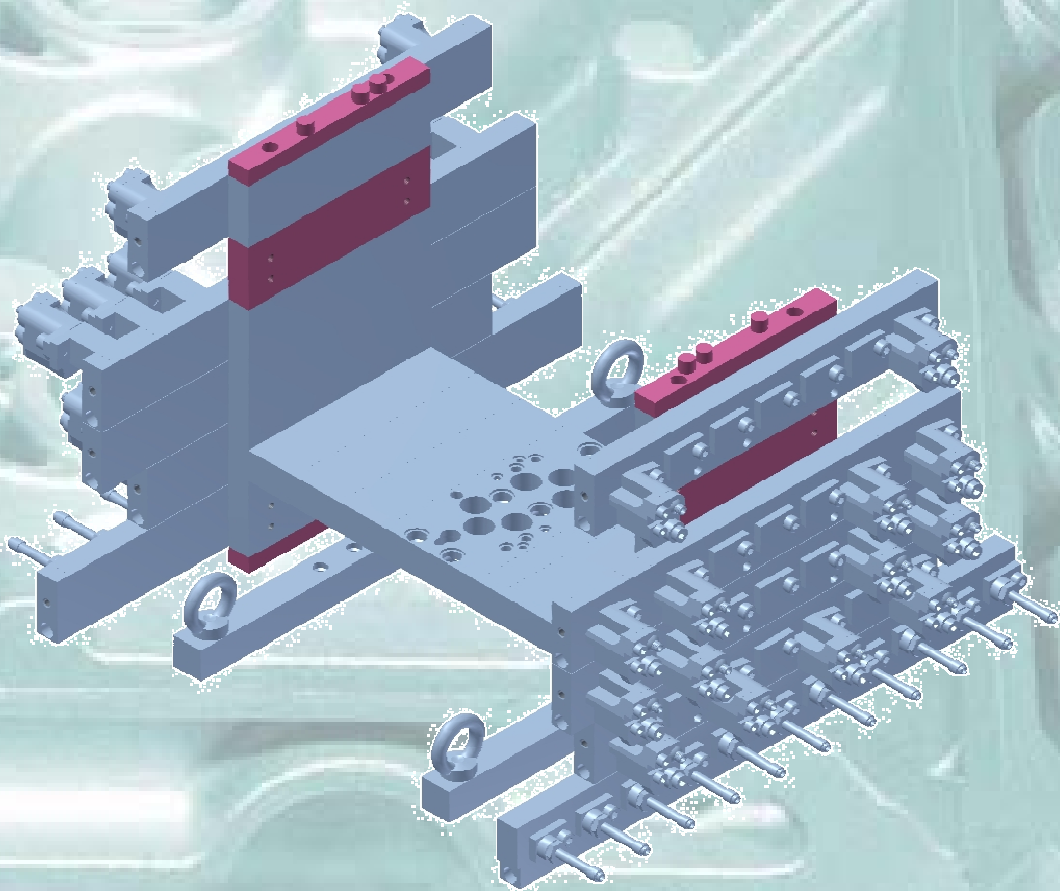



Artikelgruppe 011
prod.group 011

011.11 Artikelnr./ partno.801442		
Adaptermodul 25mm, 90° gedreht PS16/PS16C-6, komplett Adaptor module 25mm, 90° turned PS16/PS16C-6, complete		









Artikelgruppe 20 prod.group 20







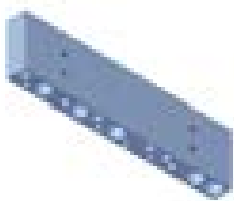





Artikelgruppe 20
prod.group 20

020.1 Artikelnr./ partno.147017		
Verteilerumlenkung HO PS16/PS16C-6, komplett, hinten/oben sprühend Distributor deflection HO PS16/PS16C-6, comple, spraying front/above		
020.2 Artikelnr./ partno.147025		
Verteilerumlenkung HU PS16/PS16C-6, komplett, hinten/unten sprühend Distributor deflection HU PS16/PS16C-6, comple, spraying rear/down		
020.3 Artikelnr./ partno.147827		
Verteilerdistanzmodul 60mm PS16/PS16C-6, komplett Distribution distance module 60mm PS16/PS16C-6, complete		
020.4 Artikelnr./ partno.147843		
Verteilerdistanzmodul 20mm PS16/PS16C-6, komplett Distribution distance module 20mm PS16/PS16C-6, complete		
020.5 Artikelnr./ partno.150185		
Verteilerschließplatte U PS16/PS16C-6, komplett, mit O-Ringen Distributor cover below PS16/PS16C-6, complete, with O-rings		







Artikelgruppe 20
 prod.group 20

<p>020.6 Artikelnr./ partno.150193</p>		
<p>Verteilerschließplatte O PS16/PS16C-6, komplett, ohne O-Ringe Distributor cover above PS16/PS16C-6, complete, without O-rings</p>		
<p>020.7 Artikelnr./ partno.207852</p>		
<p>Verteilerschließplatte U PS16/PS16C-8, komplett, mit O-Ringen Distributor cover below PS16/PS16C-8, complete, with O-rings</p>		
<p>020.8 Artikelnr./ partno.207878</p>		
<p>Verteilerschließplatte O PS16/PS16C-8, komplett, ohne O-Ringe Distributor cover above PS16/PS16C-8, complete, without O-rings</p>		
<p>020.9 Artikelnr./ partno.208009</p>		
<p>Verteilerdistanzmodul 60mm PS16/PS16C-8, komplett Distribution distance module 60mm PS16/PS16C-8, complete</p>		
<p>020.10 Artikelnr./ partno.208017</p>		
<p>Verteilerdistanzmodul 20mm PS16/PS16C-8, komplett Distribution distance module 20mm PS16/PS16C-8, complete</p>		

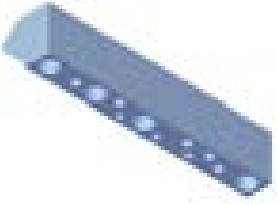
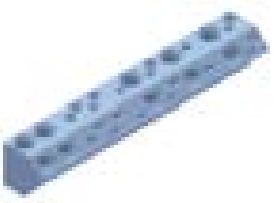
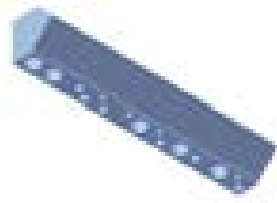
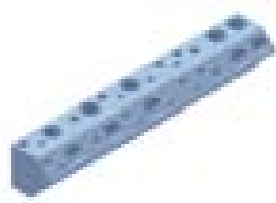









Artikelgruppe 20
 prod.group 20

020.11 Artikelnr./ partno.208058		
<p>Verteilerumlenkung HO PS16/PS16C-8, komplett, hinten/oben sprühend</p> <p>Distributor deflection HO PS16/PS16C-8, comple, spraying front/above</p>		
020.12 Artikelnr./ partno.208066		
<p>Verteilerumlenkung HU PS16/PS16C-8, komplett, hinten/unten sprühend</p> <p>Distributor deflection HU PS16/PS16C-8, comple, spraying rear/down</p>		
020.13 Artikelnr./ partno.230813		
<p>Verteileranschlußleiste PS16/PS16C-6, komplett</p> <p>Distribution connection strip PS16/PS16C-6, complete</p>		
020.14 Artikelnr./ partno.300549		
<p>Verteileranschlußleiste PS16/PS16C-8, komplett</p> <p>Distribution connection strip PS16/PS16C-8, complete</p>		
020.15 Artikelnr./ partno.306127		
<p>Verteilerumlenkung 45° VO PS16/PS16C-6, komplett, vorne/oben sprühend</p> <p>Distributor deflection 45° VO PS16/PS16C-6, complete, spraying front/above</p>		











Artikelgruppe 20
 prod.group 20

020.16 Artikelnr./ partno.306128		
<p>Verteilerumlenkung 45° VU PS16/PS16C-6, komplett, vorne/unten sprühend Distributor deflection 45° VU PS16/PS16C-6, complete, spraying front/down</p>		
020.17 Artikelnr./ partno.306129		
<p>Verteilerumlenkung 45° VO PS16/PS16C-8, komplett, vorne/oben sprühend Distributor deflection 45° VO PS16/PS16C-8, complete, spraying front/above</p>		
020.18 Artikelnr./ partno.306130		
<p>Verteilerumlenkung 45° VU PS16/PS16C-8, komplett, vorne/unten sprühend Distributor deflection 45° VU PS16/PS16C-8, complete, spraying front/down</p>		
020.19 Artikelnr./ partno.306284		
<p>Verteilerumlenkung 45° HU PS16/PS16C-6, komplett, hinten/unten sprühend Distributor deflection 45° HU PS16/PS16C-6, complete, spraying rear/down</p>		
020.20 Artikelnr./ partno.306285		
<p>Verteilerumlenkung 45° HO PS16/PS16C-6, komplett, hinten/oben sprühend Distributor deflection 45° HO PS16/PS16C-6, complete, spraying rear/above</p>		





Artikelgruppe 20
 prod.group 20

<p>020.21 Artikelnr./ partno.306295</p>		
<p>Verteilerumlenkung 45° HO PS16/PS16C-8, komplett, hinten/oben sprühend Distributor deflection 45° HO PS16/PS16C-8, complete, spraying rear/above</p>		
<p>020.22 Artikelnr./ partno.306296</p>		
<p>Verteilerumlenkung 45° HU PS16/PS16C-8, komplett, hinten/unten sprühend Distributor deflection 45° HU PS16/PS16C-8, complete, spraying rear/down</p>		
<p>020.23 Artikelnr./ partno.307736</p>		
<p>Verteilerdistanzmodul 15mm PS16/PS16C-6, komplett Distribution distance module 15mm PS16/PS16C-6, complete</p>		
<p>020.24 Artikelnr./ partno.308132</p>		
<p>Verteilerumlenkung VU mit Durchgang PS16/PS16C-6, komplett, vorne unten sprühend Distributor deflection VU with pass PS16/PS16C-6, complete (spray front-down)</p>		
<p>020.25 Artikelnr./ partno.308144</p>		
<p>Verteilerumlenkung VO mit Durchgang PS16/PS16C-6, komplett, vorne oben sprühend Distributor deflection VO with pass PS16/PS16C-6, complete (spray front-above)</p>		

Artikelgruppe 20
 prod.group 20

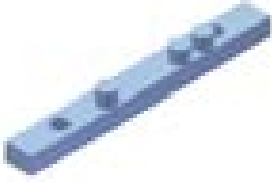
020.26 Artikelnr./ partno.800162		
Verteilerzwischenadapter PS16-6 to PS16C-6 (Kombi), komplett Distribution intermediate adaptor PS16-6 to PS16C-6 (combi)		
020.27 Artikelnr./ partno.800164		
Verteilerzwischenadapter PS16-8 to PS16C-8 (Kombi), komplett Distribution intermediate adaptor PS16-8 to PS16C-8 (combi), complete		
020.28 Artikelnr./ partno.800204		
Verteilerumlenkung VO mit Durchgang PS16/PS16C-8, komplett, vorne oben sprühend Distributor deflection VO with pass PS16/PS16C-8, complete spraying front/above		
020.29 Artikelnr./ partno.800206		
Verteilerumlenkung VU mit Durchgang PS16/PS16C-8, komplett, vorne unten sprühend Distributor deflection VU with pass PS16/PS16C-8, complete spraying front/down		
020.30 Artikelnr./ partno.801123		
Verteilerschließplatte O PS16-8, komplett, ohne O-Ringe, mit Entlüftung Distributor cover above (without O-rings), PS16-8, complete		







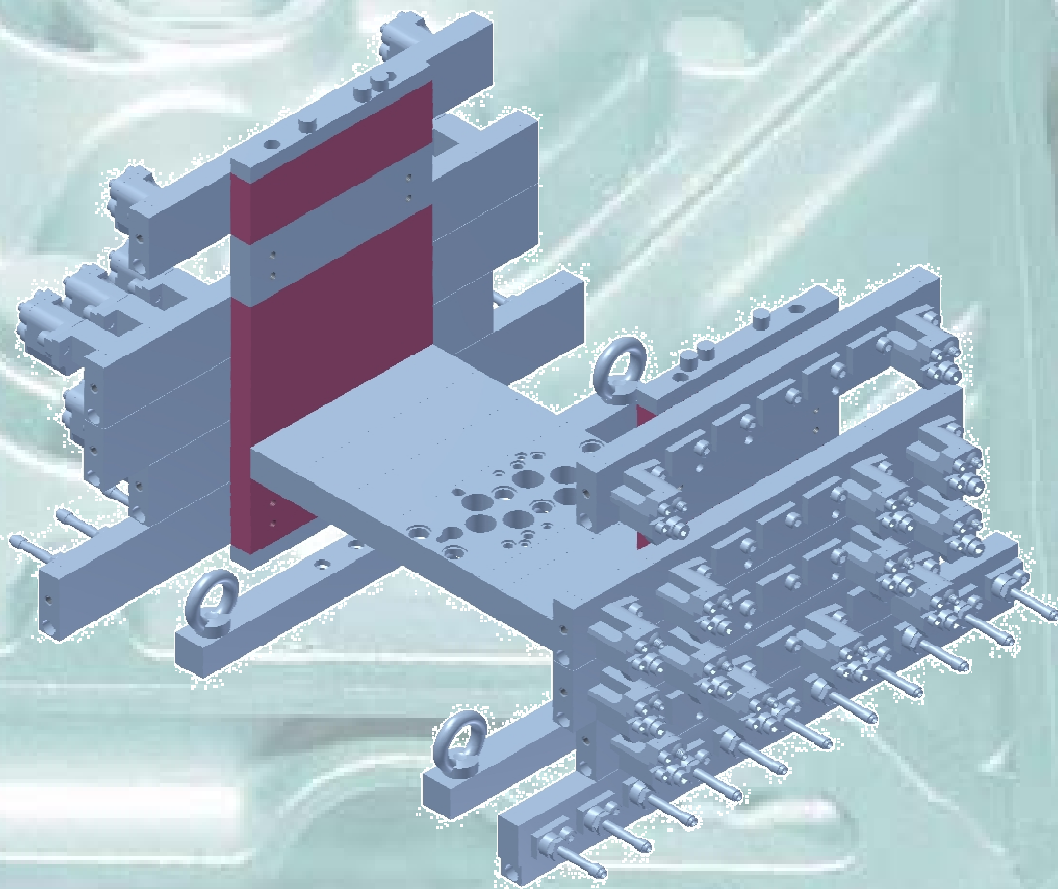

Artikelgruppe 20
prod.group 20

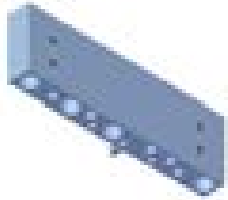
020.31 Artikelnr./ partno.801125		
Verteilerschließplatte O PS16-6, komplett, ohne O-Ringe, mit Entlüftung Distributor upper cover (without O-rings), PS16-6, complete		
020.32 Artikelnr./ partno.801307		
Verteilerdistanzmodul 10mm PS16/PS16C-6, komplett Distribution distance module 10mm PS16/PS16C-6, complete		









Artikelgruppe 21 prod.group 21

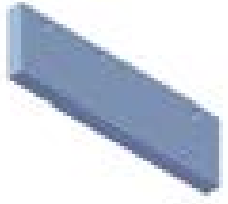

Artikelgruppe 21
prod.group 21

021.1 Artikelnr./ partno.147736		
Verteilerleistenmodul PS16-6, komplett Distribution strip module PS16-6, complete		
021.2 Artikelnr./ partno.147801		
Verteilerleiste PS16-6, komplett Distribution strip PS16-6, complete		
021.3 Artikelnr./ partno.166124		
Verteilerleistenmodul PS16-6, komplett, beidseitig Distribution strip module PS16-6, complete, two-sided		
021.4 Artikelnr./ partno.207969		
Verteilerleistenmodul PS16-8, komplett Distribution strip module PS16-8, complete		
021.5 Artikelnr./ partno.207985		
Verteilerleiste PS16-8, komplett Distribution strip PS16-8, complete		

Artikelgruppe 21
 prod.group 21

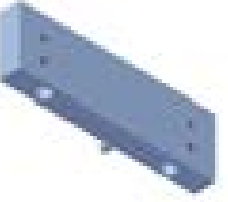
021.6 Artikelnr./ partno.225169		
Verteilerleistenverschlußplatte PS16-6 Distribution strip cover plate PS16-6		
021.7 Artikelnr./ partno.300545		
Verteilerleistenmodul PS16-8, komplett, beidseitig Distribution strip module PS16-8, complete, two-sided		
021.8 Artikelnr./ partno.301532		
Verteilerleistenverschlußplatte PS16-8 Distribution strip cover plate PS16-8		
021.9 Artikelnr./ partno.307384		
Verteilerleiste PS16-6, komplett, ohne Schließleiste distributionstrip U without closingpl. PS16-6		
021.10 Artikelnr./ partno.307393		
Verteilerleistenmodul PS16-6, komplett, ohne Schließleiste Distribution strip module PS16-6, complete, without cover		







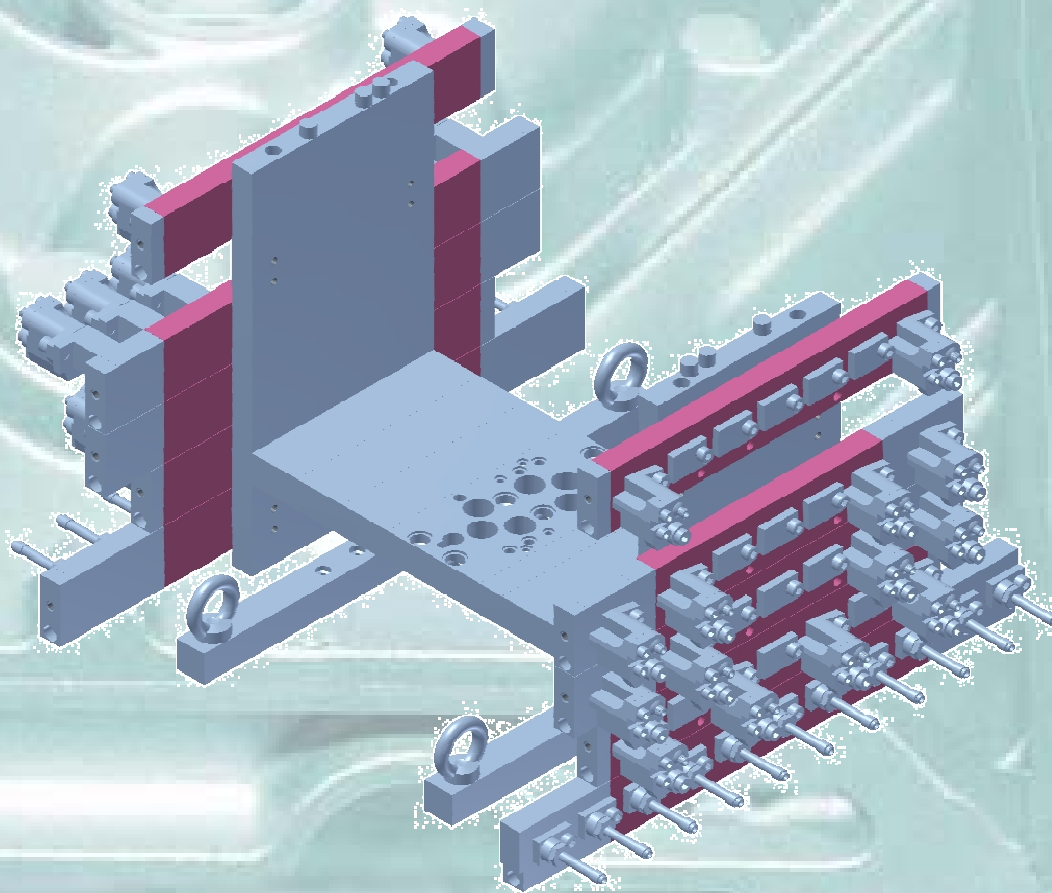



Artikelgruppe 21
prod.group 21

021.11 Artikelnr./ partno.800643		
Verteilerleistenmodul PS16-6, komplett (drei Kreise pro Reihe) Distribution strip module PS16-6, (3 circuits in a row)		
021.12 Artikelnr./ partno.800644		
Verteilerleiste PS16-6, komplett (drei Kreise pro Reihe) distributionstrip PS16-6, (3 circuits in a row)		
021.13 Artikelnr./ partno.801229		
Verteilerleistenmodul PS16-8, komplett (drei Kreise pro Reihe) distribution strip module PS16-8, (3 circuits in a row)		
021.14 Artikelnr./ partno.801231		
Verteilerleiste PS16-8, komplett (drei Kreise pro Reihe) distribution strip PS16-8, (3 circuits in a row)		











Artikelgruppe 30 prod.group 30













Artikelgruppe 30
 prod.group 30

030.1 Artikelnr./ partno.147512		
Sprühleiste 350mm Kreis 1/2 PS16-6/8, komplett Spray strip 350mm circuit 1/2 PS16-6/8, complete		
030.2 Artikelnr./ partno.147520		
Sprühleiste 350mm Kreis 3/4 PS16-6/8, komplett Spray strip 350mm circuit 3/4 PS16-6/8, complete		
030.3 Artikelnr./ partno.147538		
Sprühleiste 350mm Kreis 5/6 PS16-6/8, komplett Spray strip 350mm circuit 5/6 PS16-6/8, complete		
030.4 Artikelnr./ partno.147587		
Blasleiste 350mm PS16-6/8, komplett Blasting strip 350mm PS16-6/8, complete		
030.5 Artikelnr./ partno.179721		
Sprühleiste 250mm Kreis 3/4 PS16-6/8, komplett Spray strip 250mm circuit 3/4 PS16-6/8, complete		



Artikelgruppe 30
 prod.group 30

030.6 Artikelnr./ partno.180687		
Sprühleiste 250mm Kreis 1/2 PS16-6/8, komplett Spray strip 250mm circuit 1/2 PS16-6/8, complete		
030.7 Artikelnr./ partno.180695		
Sprühleiste 250mm Kreis 5/6 PS16-6/8, komplett Spray strip 250mm circuit 5/6 PS16-6/8, complete		
030.8 Artikelnr./ partno.180703		
Blasleiste 250mm PS16-6/8, komplett Blasting strip 250mm PS16-6/8, complete		
030.9 Artikelnr./ partno.208652		
Sprühleiste 350mm Kreis 7/8 PS16-8, komplett Spray strip 350mm circuit 7/8 PS16-8, complete		
030.10 Artikelnr./ partno.208678		
Sprühleiste 250mm Kreis 7/8 PS16-8, komplett Spray strip 250mm circuit 7/8 PS16-8, complete		

Artikelgruppe 30
 prod.group 30

030.11 Artikelnr./ partno.250720		
<p>Sprühleiste 200mm Kreis 5/6 PS16-6, komplett Spray strip 200mm circuit 5/6 PS16-6, complete</p>		
030.12 Artikelnr./ partno.250738		
<p>Sprühleiste 200mm Kreis 3/4 PS16-6, komplett Spray strip 200mm circuit 3/4 PS16-6, complete</p>		
030.13 Artikelnr./ partno.250746		
<p>Sprühleiste 200mm Kreis 1/2 PS16-6, komplett Spray strip 200mm circuit 1/2 PS16-6, complete</p>		
030.14 Artikelnr./ partno.250753		
<p>Blasleiste 200mm PS16-6, komplett Blasting strip 200mm</p>		
030.15 Artikelnr./ partno.800805		
<p>Sprühleiste 200mm Kreis 3/4-Kreis 5/6 PS16-6, komplett Spraying strip 200mm circuit 3/4-5/6 PS16-6, complete</p>		







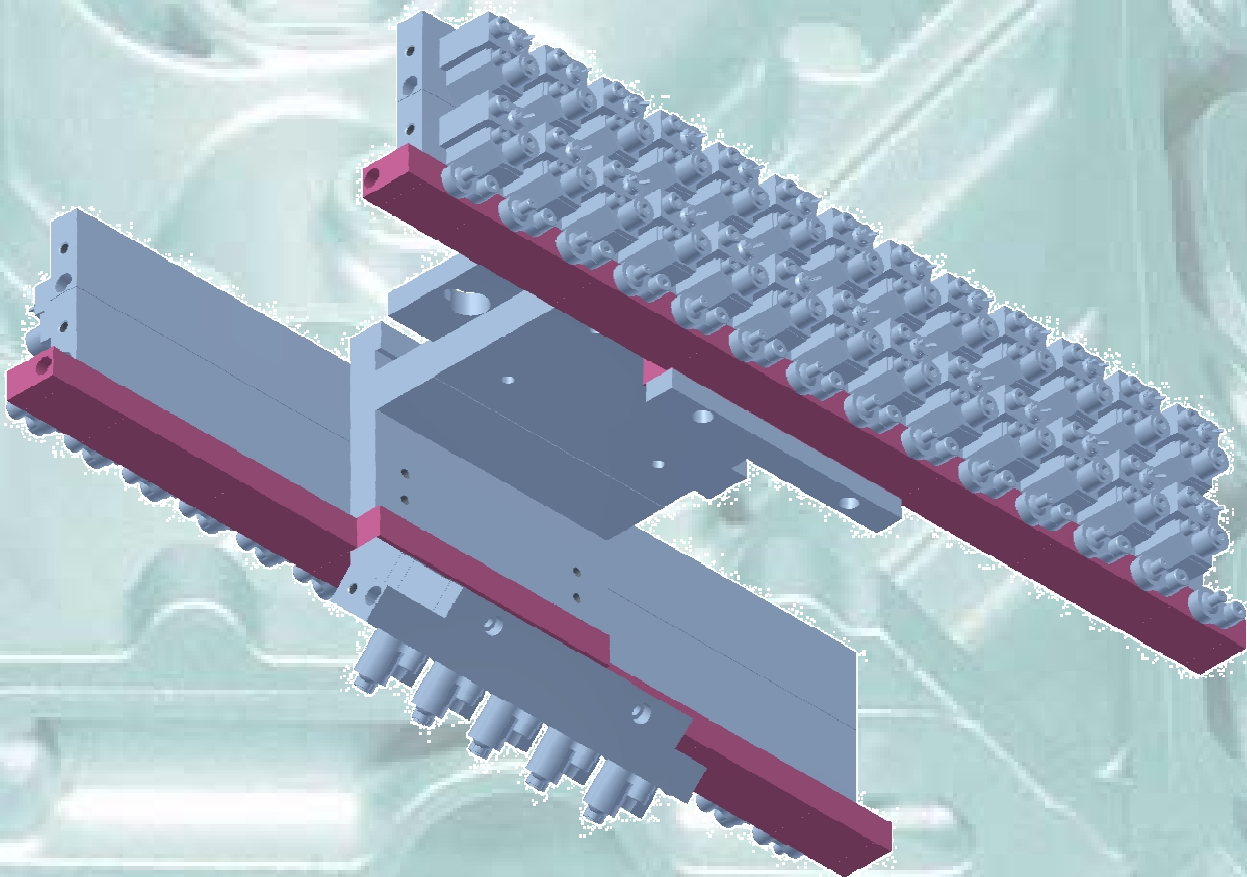



Artikelgruppe 030
prod.group 030

030.16 Artikelnr./ partno.801499		
Blasleiste 300mm PS16-6/8, komplett Blasting strip 300mm PS16-6/8, complete		











Artikelgruppe 35 prod.group 35













Artikelgruppe 35
 prod.group 35

<p>035.1 Artikelnr./ partno.800989</p>		
<p>Verteilerblasleiste 23mm PS16-6/PS16C-6, komplett Distribution blasting strip 23mm PS16-6/PS16C-6, complete</p>		
<p>035.2 Artikelnr./ partno.800990</p>		
<p>Verteilerblasschliessleiste L PS16/PS16C, komplett Distribution blasting strip cover left PS16/PS16C</p>		
<p>035.3 Artikelnr./ partno.800992</p>		
<p>Verteilerblasschliessleiste R PS16/PS16C, komplett Distribution blasting strip cover right PS16/PS16C, complete</p>		
<p>035.4 Artikelnr./ partno.800994</p>		
<p>Blasleistenmodul 50mm PS16/PS16C, komplett Blasting strip module 50mm PS16/PS16C, complete</p>		
<p>035.5 Artikelnr./ partno.800996</p>		
<p>Blasleistenmodul 100mm PS16/PS16C, komplett Blasting strip module 100mm PS16/PS16C, complete</p>		

Artikelgruppe 35
 prod.group 35

035.6 Artikelnr./ partno.801008		
Verteilerblasleiste 23mm PS16-6/PS16C-6, komplett, ohne Schließleiste Distribution blasting strip 23mm PS16-6/PS16C-6, complete, without cover		
035.7 Artikelnr./ partno.801031		
Verteilerblasleiste 23mm PS16-8/PS16C-8, komplett Distribution blasting strip 23mm PS16-8/PS16C-8, complete		
035.8 Artikelnr./ partno.801365		
Verteilerblasleiste 23mm PS16-8/PS16C-8, komplett, ohne Schließleiste unten Distribution blasting strip 23mm PS16-8/PS16C-8, complete, without cover		
035.9 Artikelnr./ partno.801559		
Blasabschlußleiste 50mm links PS16/PS16C, komplett Left end blasting strip module 50mm PS16/PS16C, complete		
035.10 Artikelnr./ partno.801647		
Verteilerblasleiste 23mm PS16-8/PS16C-8, komplett, ohne Schließleiste oben Distribution blasting strip 23mm PS16-8/PS16C-8, complete, without cover		







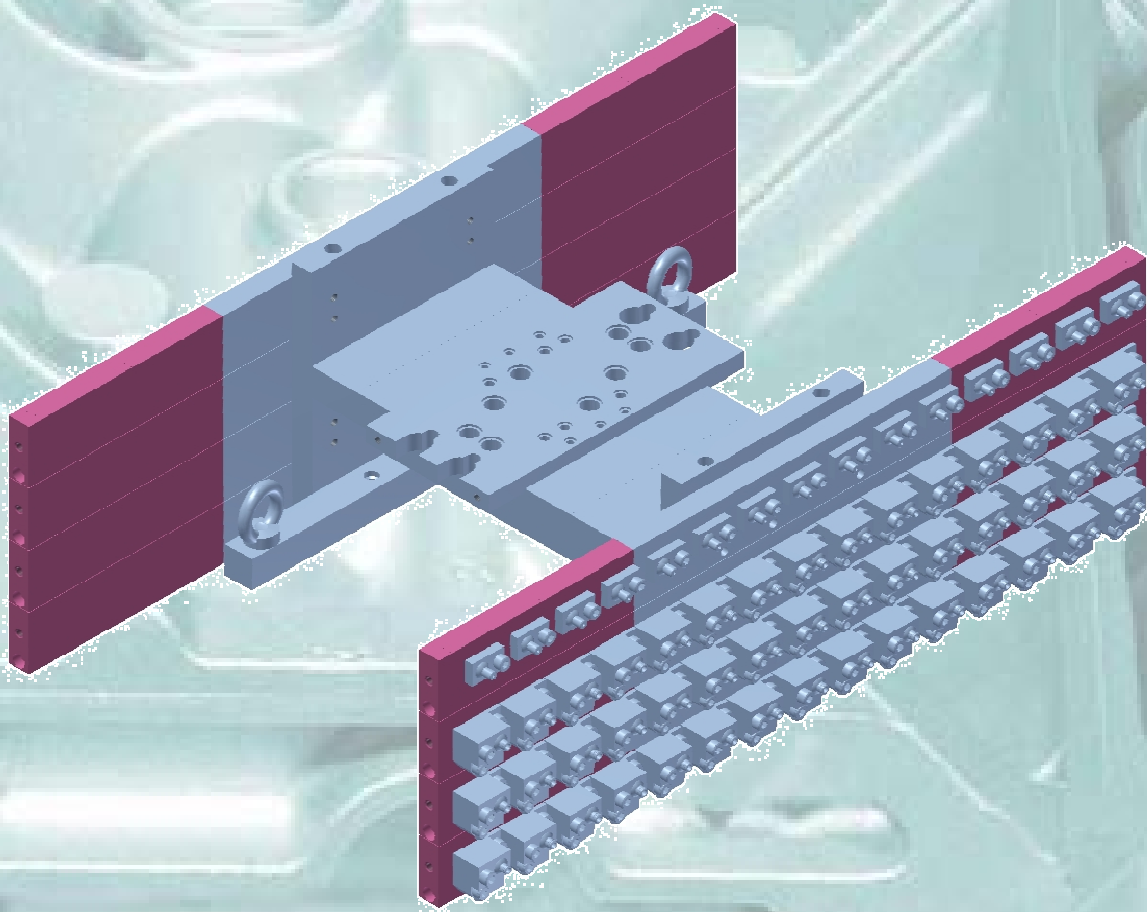



Artikelgruppe 35
 prod.group 35

035.11 Artikelnr./ partno.801665		
Blasleistenumlenkung mit Durchgang PS16/PS16C, komplett, nach oben Blasting strip deflection with pass PS16/PS16C, complete		
035.12 Artikelnr./ partno.801697		
Blasabschlußleiste 50mm rechts PS16/PS16C, komplett Right end blasting strip module 50mm PS16/PS16C, complete		
035.13 Artikelnr./ partno.801742		
Blasleistendistanzmodul 15mm PS16/PS16C, komplett		
035.14 Artikelnr./ partno.801759		
Verteilerblasleiste 23mm PS25-8, komplett, ohne Schließleiste unten Distribution blasting strip 23mm PS25-8, complete, without cover		
035.15 Artikelnr./ partno.801761		
Verteilerblasleiste 23mm PS25-8, komplett, ohne Schließleiste oben Distribution blasting strip 23mm PS25-8, complete, without cover		











Artikelgruppe 40 prod.group 40













Artikelgruppe 40
 prod.group 40

040.1 Artikelnr./ partno.141465		
<p>Sprüh-/Blasleistenmodul 100mm PS16, komplett Spray and blasting strip modul 100mm PS16, complete</p>		
040.2 Artikelnr./ partno.165910		
<p>Sprüh-/Blasleistenwinkelstück LHA PS16, komplett, links hinten außensprühend spray strip angle piece LHA PS16, complete, spraying to left, rear, outside</p>		
040.3 Artikelnr./ partno.165928		
<p>Sprüh-/Blasleistenwinkelstück LVA PS16, komplett, links vorne außensprühend Spray strip angle piece LVA PS16, complete, spraying to left, front, outside</p>		
040.4 Artikelnr./ partno.165936		
<p>Sprüh-/Blasleistenwinkelstück RHA PS16, komplett, rechts hinten außensprühend Spray strip angle piece RHA PS16, complete, spraying to right, rear, outside</p>		
040.5 Artikelnr./ partno.165944		
<p>Sprüh-/Blasleistenwinkelstück RVA PS16, komplett, rechts vorne außensprühend Spray strip angle piece RVA PS16, complete, spraying to right, front, outside</p>		









Artikelgruppe 40
 prod.group 40

<p>040.6 Artikelnr./ partno.182196</p>		
<p>Sprüh-/Blasleistenschliessleiste R PS16, komplett, mit O-Ringen Cover for spray and blasting strip R PS16, complete, with o-rings</p>		
<p>040.7 Artikelnr./ partno.182204</p>		
<p>Sprüh-/Blasleistenschliessleiste L PS16, komplett, ohne O-Ringe Cover for spray and blasting strip L PS16, complete, without o-rings</p>		
<p>040.8 Artikelnr./ partno.200972</p>		
<p>Sprüh-/Blasleistenmodul 350mm PS16, komplett Spray and blasting strip module 350mm PS16, complete</p>		
<p>040.9 Artikelnr./ partno.224279</p>		
<p>Sprüh-/Blasleistenwinkelstück LHI PS16, komplett, links hinten innensprühend Spray strip angle piece LHI PS16, complete, spraying to left, rear, inside</p>		
<p>040.10 Artikelnr./ partno.232967</p>		
<p>Sprüh-/Blasleistenwinkelstück RVI PS16, komplett, rechts vorne innensprühend Spray strip angle piece RVI PS16, complete, spraying to right, front, inside</p>		



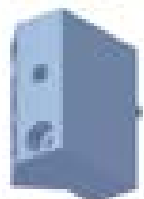







Artikelgruppe 40
 prod.group 40

040.11 Artikelnr./ partno.232991		
<p>Sprüh-/Blasleistenwinkelstück LVI PS16, komplett, links vorne innensprühend Spray strip angle piece LVI PS16, complete, spraying to left, front, inside</p>		
040.12 Artikelnr./ partno.236521		
<p>Sprüh-/Blasleistenmodul 250mm PS16, komplett Spray and blasting strip modul 250mm PS16, complete</p>		
040.13 Artikelnr./ partno.237891		
<p>Sprüh-/Blasleistenwinkelstück RHI PS16, komplett, rechts hinten innensprühend Spray strip angle piece RHI PS16, complete, spraying to right, rear, inside</p>		
040.14 Artikelnr./ partno.242073		
<p>Sprüh-/Blasleistenumlenkung RO PS16, komplett, rechts oben Spraying strip extension top right</p>		
040.15 Artikelnr./ partno.242081		
<p>Sprüh-/Blasleistendistanzmodul 25mm PS16, komplett Spray and blasting strip spacer modul 25mm PS16, complete</p>		











Artikelgruppe 40
 prod.group 40

040.16 Artikelnr./ partno.242859		
<p>Sprüh-/Blasleistenwinkelstück 45°LVI PS16, komplett, links/vorne/innensprühend Spray strip angle piece 45°LVI PS16, complete, spraying left/front/inside</p>		
040.17 Artikelnr./ partno.242867		
<p>Sprüh-/Blasleistenwinkelstück 45°LHA PS16, komplett, links/hinten/außensprühend Spray strip angle piece 45° LHA PS16, complete, spraying left/rear/outside</p>		
040.18 Artikelnr./ partno.242875		
<p>Sprüh-/Blasleistenwinkelstück 45°RVI PS16, komplett, rechts/vorne/innensprühend Spray strip angle piece 45°RVI PS16, complete, spraying right/front/inside</p>		
040.19 Artikelnr./ partno.242883		
<p>Sprüh-/Blasleistenwinkelstück 45°RHA PS16, komplett, rechts/hinten/außensprühend Spray strip angle piece 45°RHA PS16, complete, spraying right/rear/outside</p>		
040.20 Artikelnr./ partno.250506		
<p>Sprüh-/Blasleistenumlenkung LO PS16, komplett, links oben Spraying strip extension top left</p>		











Artikelgruppe 40
 prod.group 40

<p>040.21 Artikelnr./ partno.250514</p>		
<p>Sprüh-/Blasleistendistanzmodul 100mm PS16, komplett Spray and blasting strip spacer modul 100mm PS16, complete</p>		
<p>040.22 Artikelnr./ partno.250555</p>		
<p>Sprüh-/Blasleistenmodul 50mm PS16, komplett Spray and blasting strip modul 50mm PS16, complete</p>		
<p>040.23 Artikelnr./ partno.251124</p>		
<p>Sprüh-/Blasleistenkreuzung PS16, komplett Spray and blasting strip junction PS16, complete</p>		
<p>040.24 Artikelnr./ partno.302380</p>		
<p>Sprüh-/Blasleisten-Inversmodul m.O-R PS16, komplett Spray and blasting strip inverse module PS16, complete, with o-rings</p>		
<p>040.25 Artikelnr./ partno.302381</p>		
<p>Sprüh-/Blasleisten-Inversmodul o.O-R PS16, komplett Spray and blasting strip inverse module PS16, complete, without o-rings</p>		



Artikelgruppe 40
 prod.group 40

040.26 Artikelnr./ partno.303959		
<p>Sprüh-/Blasleistenmodul 50mm PS16, komplett, beidseitig Spray and blasting strip module 50mm on both sides</p>		
040.27 Artikelnr./ partno.304180		
<p>Sprüh-/Blasleistendistanzmodul 50mm PS16, komplett Spray and blasting strip spacer modul 50mm PS16, complete</p>		
040.28 Artikelnr./ partno.304182		
<p>Sprüh-/Blasleistendistanzmodul 350mm PS16, komplett Spray and blasting strip spacer modul 350mm PS16, complete</p>		
040.29 Artikelnr./ partno.304989		
<p>Sprüh-/Blasleistendistanzmodul 10mm PS16, komplett Spray and blasting strip spacer modul 10mm PS16, complete</p>		
040.30 Artikelnr./ partno.305979		
<p>Sprüh-/Blasleisten T-Stück 1 PS16, komplett Spray and blasting strip T-piece 1 PS16, complete</p>		

Artikelgruppe 40
 prod.group 40

<p>040.31 Artikelnr./ partno.305980</p> <p>Sprüh-/Blasleisten T-Stück 2 PS16, komplett</p> <p>Spray and blasting T-piece 2 PS16, complete</p>		
<p>040.32 Artikelnr./ partno.307429</p> <p>Sprüh-/Blasleistendrehmodul links PS16, komplett</p> <p>Spray and blasting strip twist modul left PS16, complete</p>		
<p>040.33 Artikelnr./ partno.307430</p> <p>Sprüh-/Blasleistendrehmodul rechts PS16, komplett</p> <p>Spray and blasting strip twist modul right PS16, complete</p>		
<p>040.34 Artikelnr./ partno.800825</p> <p>Sprüh-/Blasleistendistanzmodul 15mm PS16, komplett</p> <p>Spray and blasting strip spacer modul 15mm PS16, complete</p>		
<p>040.35 Artikelnr./ partno.801738</p> <p>Sprüh-/Blasabschlußleiste 50mm links PS16, komplett</p> <p>Left end spray and blasting strip module 50mm PS16, complete</p>		







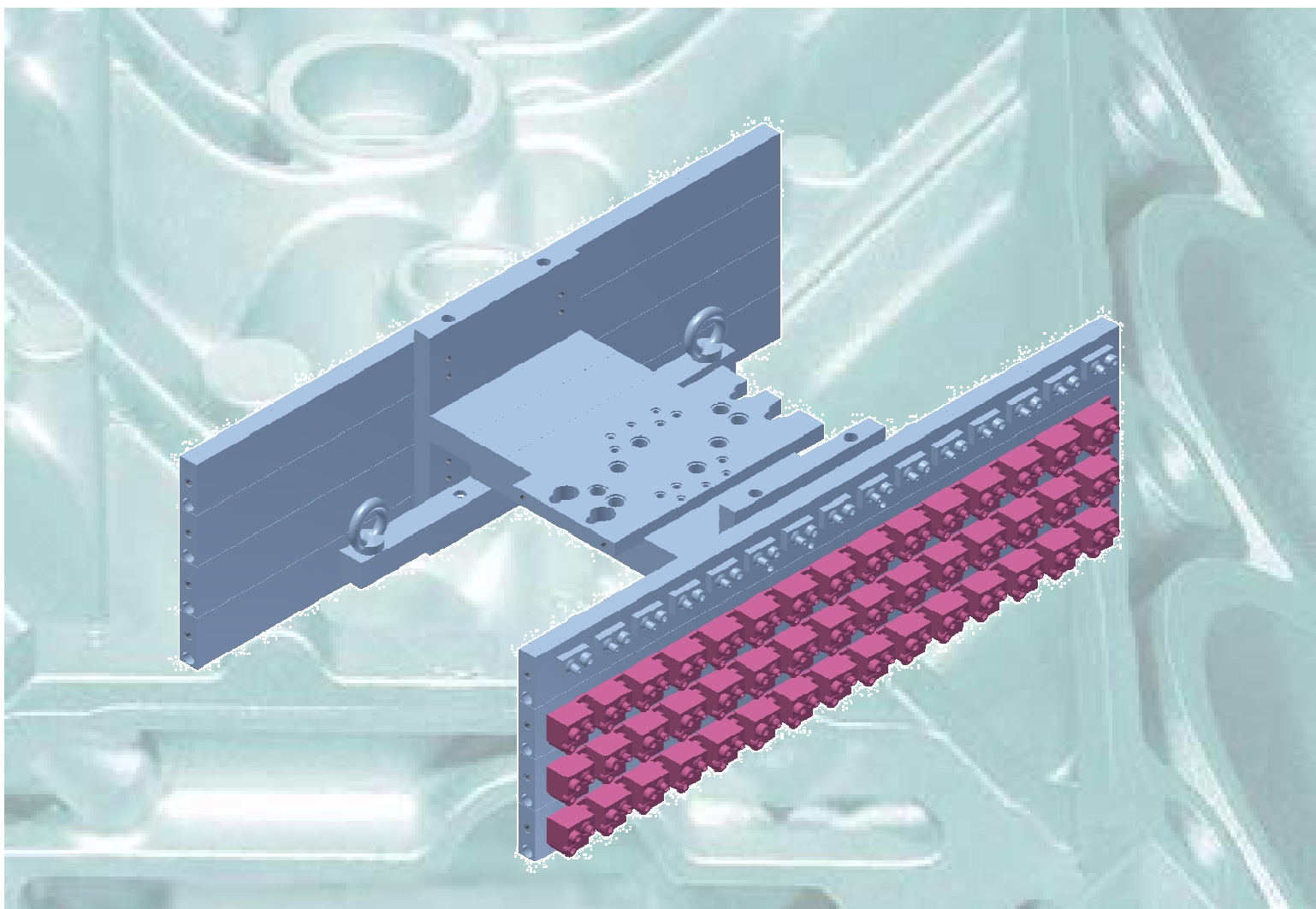



Artikelgruppe 040
prod.group 040

040.36 Artikelnr./ partno.801740		
Sprüh-/Blasabschlußleiste 50mm rechts PS16, komplett Right end spray and blasting strip module 50mm PS16, complete		











Artikelgruppe 50 prod.group 50













Artikelgruppe 50
 prod.group 50

050.1 Artikelnr./ partno.177683		
Sprühdüse SD12 SD-A-02+DB-1-06+KD-A-06 Spray nozzle SD12 SD-A-02+DB-1-06+KD-A-06		
050.2 Artikelnr./ partno.177691		
Sprühdüse SD13 SD-A-03+KD-A-06 Spray nozzle SD13 SD-A-03+KD-A-06		
050.3 Artikelnr./ partno.245068		
Sprühdüse SD12 Basis SD-A-02 Spray nozzle SD12 carrier SD-A-02		
050.4 Artikelnr./ partno.245076		
Sprühdüse SD13 Basis SD-A-03 Spray nozzle SD13 carrier SD-A-03		
050.5 Artikelnr./ partno.305705		
Sprühdüse SD12 SD-A-02+DB-1-06+KD-A-10 Spray nozzle SD12 SD-A-02+DB-1-06+KD-A-10		











Artikelgruppe 50
 prod.group 50

050.6 Artikelnr./ partno.800213		
Sprühdüse SD13 SD-A-03+KD-A-10 Spray nozzle SD13 SD-A-03+KD-A-10		
050.7 Artikelnr./ partno.800364		
Sprühdüse SD13 SD-A-03+KD-A-02 Spray nozzle SD13 SD-A-03+KD-A-02		
050.8 Artikelnr./ partno.800365		
Sprühdüse SD13 SD-A-03+KD-A-04 Spray nozzle SD13 SD-A-03+KD-A-04		
050.9 Artikelnr./ partno.800388		
Sprühdüse SD13 SD-A-03+KD-A-08 Spray nozzle SD13 SD-A-03+KD-A-08		
050.10 Artikelnr./ partno.800420		
Sprühdüse SD12 SD-A-02+DB-0-04+KD-A-06 Spray nozzle SD12 SD-A-02+DB-0-04+KD-A-06		











Artikelgruppe 50
 prod.group 50

050.11 Artikelnr./ partno.800421		
Sprühdüse SD12 SD-A-02+DB-3-10+KD-A-10 Spray nozzle SD12 SD-A-02+DB-3-10+KD-A-10		
050.12 Artikelnr./ partno.800422		
Sprühdüse SD12 SD-A-02+DB-0-04+KD-A-04 Spray nozzle SD12 SD-A-02+DB-0-04+KD-A-04		
050.13 Artikelnr./ partno.800443		
Sprühdüse SD12 SD-A-02+DB-0-04+KD-A-08 Spray nozzle SD12 SD-A-02+DB-0-04+KD-A-08		
050.14 Artikelnr./ partno.800444		
Sprühdüse SD12 SD-A-02+DB-0-04+KD-A-10 Spray nozzle SD12 SD-A-02+DB-0-04+KD-A-10		
050.15 Artikelnr./ partno.800445		
Sprühdüse SD12 SD-A-02+DB-1-06+KD-A-08 Spray nozzle SD12 SD-A-02+DB-1-06+KD-A-08		











Artikelgruppe 50
 prod.group 50

050.16 Artikelnr./ partno.800446		
<p>Sprühdüse SD12 SD-A-02+DB-1-06+KD-A-15</p> <p>Spray nozzle SD12 SD-A-02+DB-1-06+KD-A-15</p>		
050.17 Artikelnr./ partno.800447		
<p>Sprühdüse SD12 SD-A-02+DB-2-08+KD-A-08</p> <p>Spray nozzle SD12 SD-A-02+DB-2-08+KD-A-08</p>		
050.18 Artikelnr./ partno.800448		
<p>Sprühdüse SD12 SD-A-02+DB-2-08+KD-A-10</p> <p>Spray nozzle SD12 SD-A-02+DB-2-08+KD-A-10</p>		
050.19 Artikelnr./ partno.800449		
<p>Sprühdüse SD12 SD-A-02+DB-2-08+KD-A-15</p> <p>Spray nozzle SD12 SD-A-02+DB-2-08+KD-A-15</p>		
050.20 Artikelnr./ partno.800450		
<p>Sprühdüse SD12 SD-A-02+DB-2-08+KD-A-20</p> <p>Spray nozzle SD12 SD-A-02+DB-2-08+KD-A-20</p>		











Artikelgruppe 50
 prod.group 50

050.21 Artikelnr./ partno.800451		
<p>Sprühdüse SD12 SD-A-02+DB-3-10+KD-A-15</p> <p>Spray nozzle SD12 SD-A-02+DB-3-10+KD-A-15</p>		
050.22 Artikelnr./ partno.800452		
<p>Sprühdüse SD12 SD-A-02+DB-3-10+KD-A-20</p> <p>Spray nozzle SD12 SD-A-02+DB-3-10+KD-A-20</p>		
050.23 Artikelnr./ partno.800453		
<p>Sprühdüse SD12 SD-A-02+DB-4-12+KD-A-15</p> <p>Spray nozzle SD12 SD-A-02+DB-4-12+KD-A-15</p>		
050.24 Artikelnr./ partno.800454		
<p>Sprühdüse SD12 SD-A-02+DB-4-12+KD-A-20</p> <p>Spray nozzle SD12 SD-A-02+DB-4-12+KD-A-20</p>		
050.25 Artikelnr./ partno.800455		
<p>Sprühdüse SD12 SD-A-02+DB-5-16+KD-A-15</p> <p>Spray nozzle SD12 SD-A-02+DB-5-16+KD-A-15</p>		











Artikelgruppe 50
 prod.group 50

050.26 Artikelnr./ partno.800456		
Sprühdüse SD12 SD-A-02+DB-5-16+KD-A-20 Spray nozzle SD12 SD-A-02+DB-5-16+KD-A-20		
050.27 Artikelnr./ partno.800457		
Sprühdüse SD12 SD-A-02+DB-6-20+KD-A-20 Spray nozzle SD12 SD-A-02+DB-6-20+KD-A-20		
050.28 Artikelnr./ partno.800458		
Sprühdüse SD13 SD-A-03+KD-A-15 Spray nozzle SD13 SD-A-03+KD-A-15		
050.29 Artikelnr./ partno.800459		
Sprühdüse SD13 SD-A-03+KD-A-20 Spray nozzle SD13 SD-A-03+KD-A-20		
050.30 Artikelnr./ partno.800460		
Sprühdüse SD13 SD-A-03+KD-A-F Spray nozzle SD13 SD-A-03+KD-A-F		











Artikelgruppe 50
 prod.group 50

050.31 Artikelnr./ partno.800461		
Sprühdüse SD13 SD-A-03+KD-A-B Spray nozzle SD13 SD-A-03+KD-A-B		
050.32 Artikelnr./ partno.800462		
Sprühdüse SD12 SD-A-02+DB-E+KD-A-04 Spray nozzle SD12 SD-A-02+DB-E+KD-A-04		
050.33 Artikelnr./ partno.800463		
Sprühdüse SD12 SD-A-02+DB-E+KD-A-06 Spray nozzle SD12 SD-A-02+DB-E+KD-A-06		
050.34 Artikelnr./ partno.800464		
Sprühdüse SD12 SD-A-02+DB-E+KD-A-08 Spray nozzle SD12 SD-A-02+DB-E+KD-A-08		
050.35 Artikelnr./ partno.800465		
Sprühdüse SD12 SD-A-02+DB-E+KD-A-10 Spray nozzle SD12 SD-A-02+DB-E+KD-A-10		











Artikelgruppe 50
 prod.group 50

050.36 Artikelnr./ partno.800466		
Sprühdüse SD12 SD-A-02+DB-E+KD-A-15 Spray nozzle SD12 SD-A-02+DB-E+KD-A-15		
050.37 Artikelnr./ partno.800467		
Sprühdüse SD12 SD-A-02+DB-E+KD-A-20 Spray nozzle SD12 SD-A-02+DB-E+KD-A-20		
050.38 Artikelnr./ partno.800491		
Sprühdüse SD12 SD-A-02+DB-E+KD-A-02 Spray nozzle SD12 SD-A-02+DB-E+KD-A-02		
050.39 Artikelnr./ partno.800492		
Sprühdüse SD12 SD-A-02+DB-0-04+KD-A-F Spray nozzle SD12 SD-A-02+DB-0-04+KD-A-F		
050.40 Artikelnr./ partno.800493		
Sprühdüse SD12 SD-A-02+DB-0-04+KD-A-B Spray nozzle SD12 SD-A-02+DB-0-04+KD-A-B		











Artikelgruppe 50
 prod.group 50

050.41 Artikelnr./ partno.800494		
Sprühdüse SD12 SD-A-02+DB-1-06+KD-A-F Spray nozzle SD12 SD-A-02+DB-1-06+KD-A-F		
050.42 Artikelnr./ partno.800495		
Sprühdüse SD12 SD-A-02+DB-1-06+KD-A-B Spray nozzle SD12 SD-A-02+DB-1-06+KD-A-B		
050.43 Artikelnr./ partno.800496		
Sprühdüse SD12 SD-A-02+DB-2-08+KD-A-F Spray nozzle SD12 SD-A-02+DB-2-08+KD-A-F		
050.44 Artikelnr./ partno.800497		
Sprühdüse SD12 SD-A-02+DB-2-08+KD-A-B Spray nozzle SD12 SD-A-02+DB-2-08+KD-A-B		
050.45 Artikelnr./ partno.800498		
Sprühdüse SD12 SD-A-02+DB-3-10+KD-A-F Spray nozzle SD12 SD-A-02+DB-3-10+KD-A-F		

Artikelgruppe 50
 prod.group 50

050.46 Artikelnr./ partno.800499		
Sprühdüse SD12 SD-A-02+DB-3-10+KD-A-B Spray nozzle SD12 SD-A-02+DB-3-10+KD-A-B		
050.47 Artikelnr./ partno.800500		
Sprühdüse SD12 SD-A-02+DB-4-12+KD-A-F Spray nozzle SD12 SD-A-02+DB-4-12+KD-A-F		
050.48 Artikelnr./ partno.800501		
Sprühdüse SD12 SD-A-02+DB-4-12+KD-A-B Spray nozzle SD12 SD-A-02+DB-4-12+KD-A-B		
050.49 Artikelnr./ partno.800502		
Sprühdüse SD12 SD-A-02+DB-5-16+KD-A-F Spray nozzle SD12 SD-A-02+DB-5-16+KD-A-F		
050.50 Artikelnr./ partno.800503		
Sprühdüse SD12 SD-A-02+DB-5-16+KD-A-B Spray nozzle SD12 SD-A-02+DB-5-16+KD-A-B		







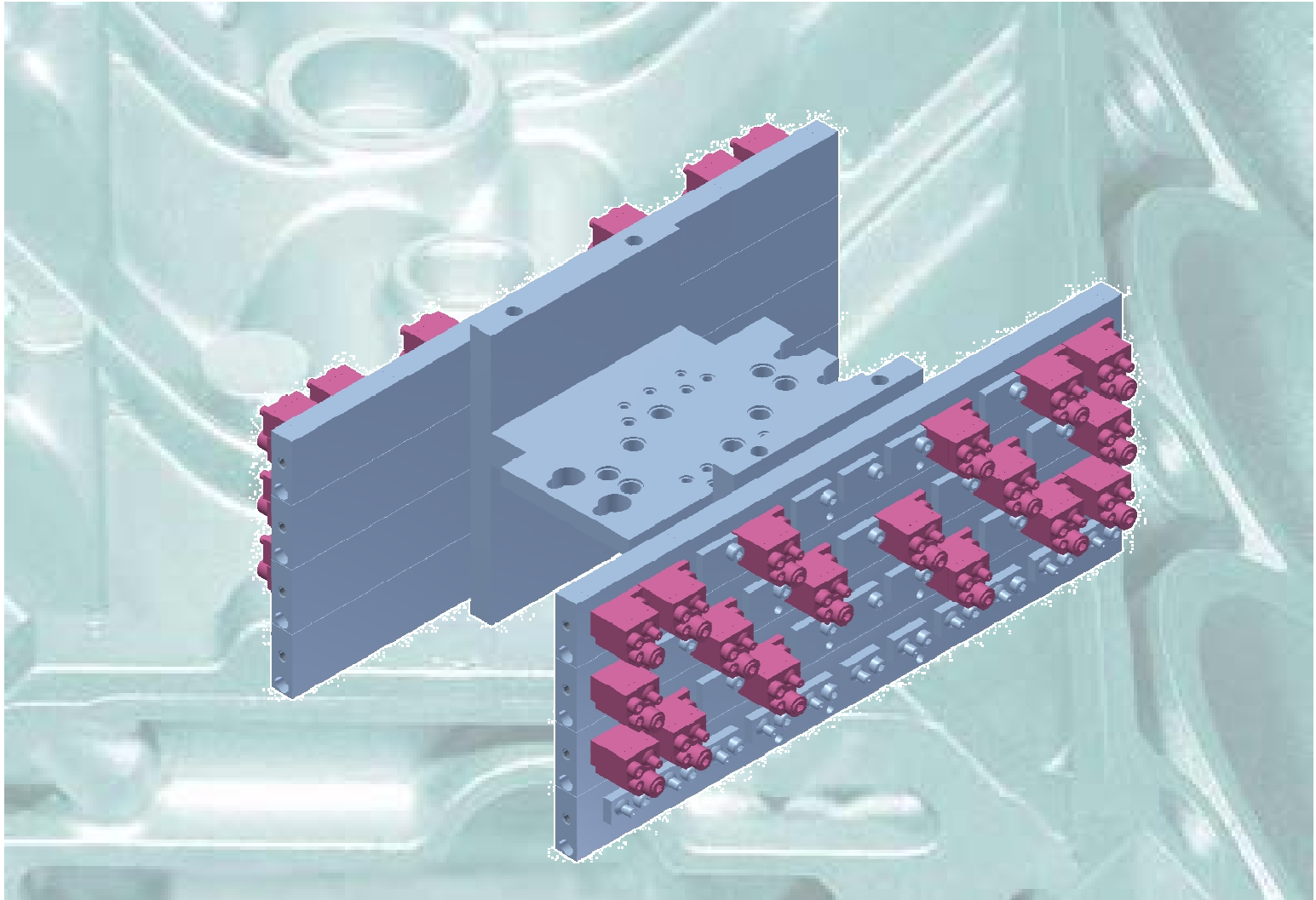



Artikelgruppe 50
 prod.group 50

050.51 Artikelnr./ partno.800504		
<p>Sprühdüse SD12 SD-A-02+DB-6-20+KD-A-F</p> <p>Spray nozzle SD12 SD-A-02+DB-6-20+KD-A-F</p>		
050.52 Artikelnr./ partno.800505		
<p>Sprühdüse SD12 SD-A-02+DB-6-20+KD-A-B</p> <p>Spray nozzle SD12 SD-A-02+DB-6-20+KD-A-B</p>		
050.53 Artikelnr./ partno.800506		
<p>Sprühdüse SD12 SD-A-02+DB-E+KD-A-F</p> <p>Spray nozzle SD12 SD-A-02+DB-E+KD-A-F</p>		
050.54 Artikelnr./ partno.800507		
<p>Sprühdüse SD12 SD-A-02+DB-E+KD-A-B</p> <p>Spray nozzle SD12 SD-A-02+DB-E+KD-A-B</p>		
050.55 Artikelnr./ partno.800864		
<p>Sprühdüse SD13 SD-A-03+KD-A-10-S (Edelstahl)</p> <p>Spray nozzle SD13 SD-A-03+KD-A-10</p>		











Artikelgruppe 60 prod.group 60













Artikelgruppe 60
 prod.group 60

060.1 Artikelnr./ partno.137711		
Sprühdüse SD3 SD-I-03+KD-I-26 Spray nozzle SD3 SD-I-03+KD-I-26		
060.2 Artikelnr./ partno.139261		
Sprühdüse SD2 SD-I-02+DB-1-06+KD-I-26 Spray nozzle SD2 SD-I-02+DB-1-06+KD-I-26		
060.3 Artikelnr./ partno.245035		
Sprühdüse SD2 Basis SD-I-02 Spray nozzle SD2 carrier SD-I-02		
060.4 Artikelnr./ partno.245043		
Sprühdüse SD3 Basis SD-I-03 Spray nozzle SD3 carrier SD-I-03		
060.5 Artikelnr./ partno.800362		
Sprühdüse SD3 SD-I-03+KD-I-F Spray nozzle SD3 SD-I-03+KD-I-F		











Artikelgruppe 60
 prod.group 60

060.6 Artikelnr./ partno.800363		
Sprühdüse SD3 SD-I-03+KD-I-B Spray nozzle SD3 SD-I-03+KD-I-B		
060.7 Artikelnr./ partno.800468		
Sprühdüse SD2 SD-I-02+DB-0-04+KD-I-26 Spray nozzle SD2 SD-I-02+DB-0-04+KD-I-26		
060.8 Artikelnr./ partno.800469		
Sprühdüse SD2 SD-I-02+DB-0-04+KD-I-F Spray nozzle SD2 SD-I-02+DB-0-04+KD-I-F		
060.9 Artikelnr./ partno.800470		
Sprühdüse SD2 SD-I-02+DB-0-04+KD-I-B Spray nozzle SD2 SD-I-02+DB-0-04+KD-I-B		
060.10 Artikelnr./ partno.800471		
Sprühdüse SD2 SD-I-02+DB-1-06+KD-I-F Spray nozzle SD2 SD-I-02+DB-1-06+KD-I-F		











Artikelgruppe 60
 prod.group 60

060.11 Artikelnr./ partno.800472		
Sprühdüse SD2 SD-I-02+DB-1-06+KD-I-B Spray nozzle SD2 SD-I-02+DB-1-06+KD-I-B		
060.12 Artikelnr./ partno.800473		
Sprühdüse SD2 SD-I-02+DB-2-08+KD-I-26 Spray nozzle SD2 SD-I-02+DB-2-08+KD-I-26		
060.13 Artikelnr./ partno.800474		
Sprühdüse SD2 SD-I-02+DB-2-08+KD-I-F Spray nozzle SD2 SD-I-02+DB-2-08+KD-I-F		
060.14 Artikelnr./ partno.800475		
Sprühdüse SD2 SD-I-02+DB-2-08+KD-I-B Spray nozzle SD2 SD-I-02+DB-2-08+KD-I-B		
060.15 Artikelnr./ partno.800476		
Sprühdüse SD2 SD-I-02+DB-3-10+KD-I-26 Spray nozzle SD2 SD-I-02+DB-3-10+KD-I-26		











Artikelgruppe 60
 prod.group 60

060.16 Artikelnr./ partno.800477		
Sprühdüse SD2 SD-I-02+DB-3-10+KD-I-F Spray nozzle SD2 SD-I-02+DB-3-10+KD-I-F		
060.17 Artikelnr./ partno.800478		
Sprühdüse SD2 SD-I-02+DB-3-10+KD-I-B Spray nozzle SD2 SD-I-02+DB-3-10+KD-I-B		
060.18 Artikelnr./ partno.800479		
Sprühdüse SD2 SD-I-02+DB-4-12+KD-I-26 Spray nozzle SD2 SD-I-02+DB-4-12+KD-I-26		
060.19 Artikelnr./ partno.800480		
Sprühdüse SD2 SD-I-02+DB-4-12+KD-I-F Spray nozzle SD2 SD-I-02+DB-4-12+KD-I-F		
060.20 Artikelnr./ partno.800481		
Sprühdüse SD2 SD-I-02+DB-4-12+KD-I-B Spray nozzle SD2 SD-I-02+DB-4-12+KD-I-B		

Artikelgruppe 60
 prod.group 60

060.21 Artikelnr./ partno.800482		
<p>Sprühdüse SD2 SD-I-02+DB-5-16+KD-I-26</p> <p>Spray nozzle SD2 SD-I-02+DB-5-16+KD-I-26</p>		
060.22 Artikelnr./ partno.800483		
<p>Sprühdüse SD2 SD-I-02+DB-5-16+KD-I-F</p> <p>Spray nozzle SD2 SD-I-02+DB-5-16+KD-I-F</p>		
060.23 Artikelnr./ partno.800484		
<p>Sprühdüse SD2 SD-I-02+DB-5-16+KD-I-B</p> <p>Spray nozzle SD2 SD-I-02+DB-5-16+KD-I-B</p>		
060.24 Artikelnr./ partno.800485		
<p>Sprühdüse SD2 SD-I-02+DB-6-20+KD-I-26</p> <p>Spray nozzle SD2 SD-I-02+DB-6-20+KD-I-26</p>		
060.25 Artikelnr./ partno.800486		
<p>Sprühdüse SD2 SD-I-02+DB-6-20+KD-I-F</p> <p>Spray nozzle SD2 SD-I-02+DB-6-20+KD-I-F</p>		

Artikelgruppe 60
 prod.group 60

060.26 Artikelnr./ partno.800487		
<p>Sprühdüse SD2 SD-I-02+DB-6-20+KD-I-B</p> <p>Spray nozzle SD2 SD-I-02+DB-6-20+KD-I-B</p>		
060.27 Artikelnr./ partno.800488		
<p>Sprühdüse SD2 SD-I-02+DB-E+KD-I-26</p> <p>Spray nozzle SD2 SD-I-02+DB-E+KD-I-26</p>		
060.28 Artikelnr./ partno.800489		
<p>Sprühdüse SD2 SD-I-02+DB-E+KD-I-F</p> <p>Spray nozzle SD2 SD-I-02+DB-E+KD-I-F</p>		
060.29 Artikelnr./ partno.800490		
<p>Sprühdüse SD2 SD-I-02+DB-E+KD-I-B</p> <p>Spray nozzle SD2 SD-I-02+DB-E+KD-I-B</p>		
060.30 Artikelnr./ partno.800592		
<p>Sprühdüse SD2 SD-I-02+DB-OB+KD-I-35</p> <p>Spray nozzle SD2 SD-I-02+DB-1-06+KD-I-26</p>		

Artikelgruppe 70 prod.group 70

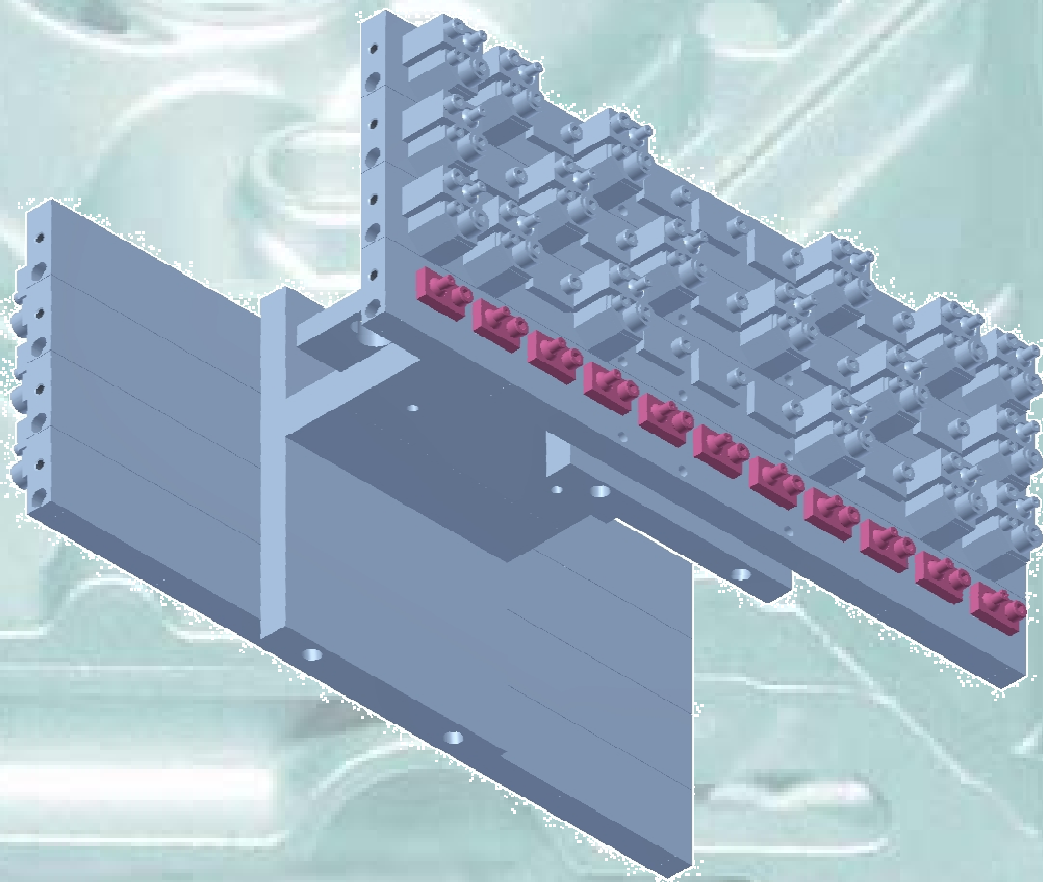

Artikelgruppe 70
prod.group 70

070.1 Artikelnr./ partno.142422		
<p>Blas-Set mit KD-I-26 mit Einsatz, mit Schraube M8, rechteckig</p> <p>Blasting set with KD-I-26 with insert, with screw M8, rectangular</p>		



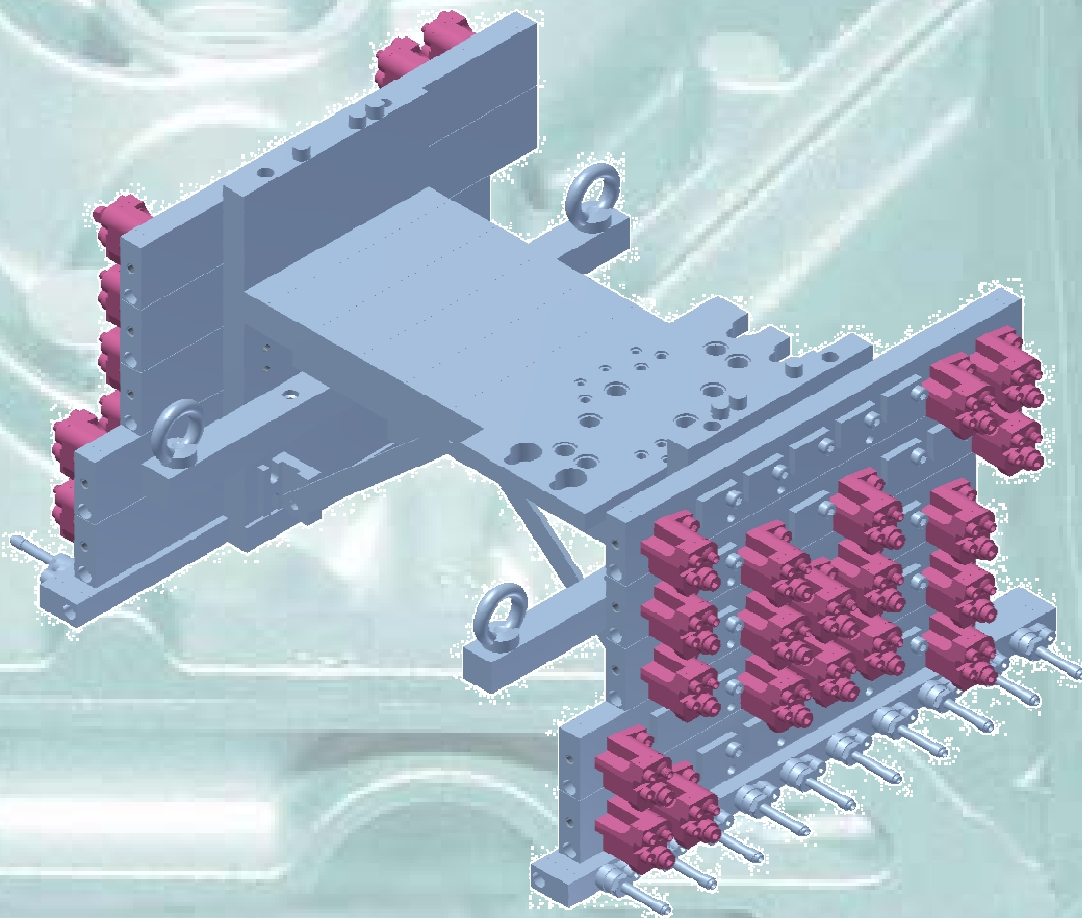







Artikelgruppe 80 prod.group 80













Artikelgruppe 80
 prod.group 80

080.1 Artikelnr./ partno.800413		
Dosierdüse DD-A-4-76-V+KD-A-06 Dosing nozzle DD-A-4-76-V+KD-A-06		
080.2 Artikelnr./ partno.800593		
Dosierdüse Basis DD-A-4-76-V dosing nozzle carrier DD-A-4-76-V		
080.3 Artikelnr./ partno.800807		
Dosierdüse DD-A-3-43-V+KD-A-06 Dosing nozzle DD-A-3-43-V+KD-A-06		
080.4 Artikelnr./ partno.801120		
Dosierdüse Basis DD-A-3-43-V dosing nozzle carrier DD-A-3-43-V		
080.5 Artikelnr./ partno.801130		
Dosierdüse DD-A-5-119-V+KD-A-06 Dosing nozzle DD-A-5-119-V+KD-A-06		











Artikelgruppe 80
 prod.group 80

080.6 Artikelnr./ partno.801149		
Dosierdüse Basis DD-A-5-119-V dosing nozzle carrier DD-A-5-119-V		
080.7 Artikelnr./ partno.801285		
Dosierdüse DDV-A-4-76-V+KD-A-06 Dosing nozzle DDV-A-4-76-V+KD-A-06		
080.8 Artikelnr./ partno.801329		
Dosierdüse DDV-A-3-43-V+KD-A-06 Dosing nozzle DDV-A-3-43-V+KD-A-06		
080.9 Artikelnr./ partno.801333		
Dosierdüse Basis DDV-A-4-76-V Dosing nozzle carrier DDV-A-4-76-V		
080.10 Artikelnr./ partno.801337		
Dosierdüse DDV-A-2-19-V+KD-A-06 Dosing nozzle DDV-A-2-19-V+KD-A-06		







Artikelgruppe 80
prod.group 80

080.11 Artikelnr./ partno.801338		
Dosierdüse DDV-A-5-119-V+KD-A-06 Dosing nozzle DDV-A-5-119-V+KD-A-06		
080.12 Artikelnr./ partno.801511		
Dosierdüse Basis DDV-A-3-43-V Dosing nozzle carrier DDV-A-3-43-V		
080.13 Artikelnr./ partno.801588		
Kappe mit Festanschlag 1 für Dosierdüse, komplett Cap with fixed stop 1 for dosing nozzle, complete		
080.14 Artikelnr./ partno.801589		
Kappe mit Festanschlag 2 für Dosierdüse, komplett Cap with fixed stop 2 for dosing nozzle, complete		
080.15 Artikelnr./ partno.801590		
Kappe mit Festanschlag 3 für Dosierdüse, komplett Cap with fixed stop 3 for dosing nozzle, complete		

Artikelgruppe 80
 prod.group 80

080.16 Artikelnr./ partno.801591		
<p>Kappe mit Festanschlag 4 für Dosierdüse, komplett Cap with fixed stop 4 for dosing nozzle, complete</p>		
080.17 Artikelnr./ partno.801592		
<p>Kappe mit Festanschlag 5 für Dosierdüse, komplett Cap with fixed stop 5 for dosing nozzle, complete</p>		
080.18 Artikelnr./ partno.801593		
<p>Kappe mit Festanschlag 6 für Dosierdüse, komplett Cap with fixed stop 6 for dosing nozzle, complete</p>		
080.19 Artikelnr./ partno.801622		
<p>Dosierdüse Basis DDV-A-5-119-V Dosing nozzle carrier DDV-A-5-119-V</p>		
080.20 Artikelnr./ partno.801681		
<p>Sprühdüse FSD FSD-A-10+KD-A-06 Spray nozzle FSD FSD-A-10+KD-A-06</p>		







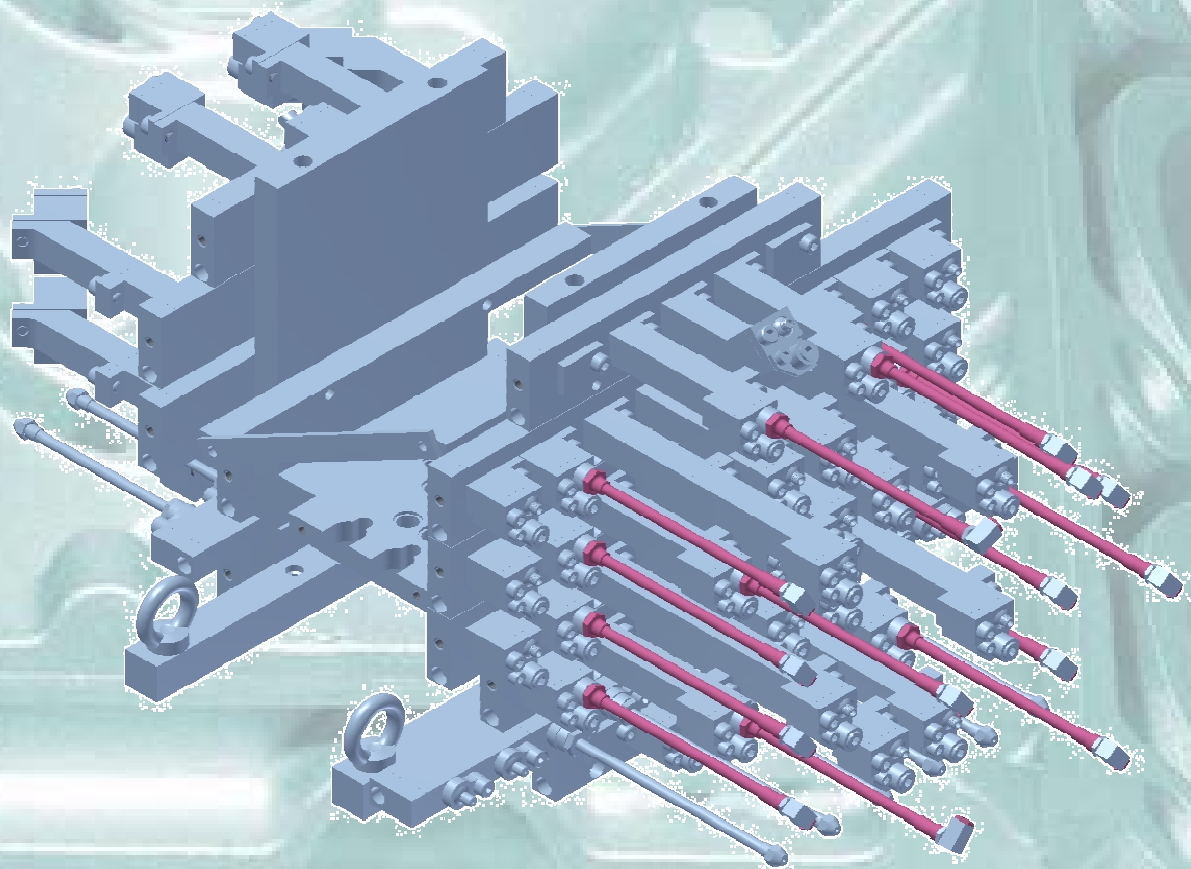



Artikelgruppe 80
 prod.group 80

080.21 Artikelnr./ partno.801690		
Sprühdüse FSD FSD-A-10+KD-A-04 Spray nozzle FSD FSD-A-10+KD-A-04		
080.22 Artikelnr./ partno.801691		
Sprühdüse FSD Basis FSD-A-10 Spray nozzle FSD basis FSD-A-10		
080.23 Artikelnr./ partno.801782		
Sprühdüse FSD FSD-A-10+KD-A-F-03-FZ Spray nozzle FSD FSD-A-09+KD-A-F-03-FZ		











Artikelgruppe 90 prod.group 90





Artikelgruppe 90
prod.group 90

090.1 Artikelnr./ partno.177733		
Rohr R-A-100 Tube R-A-100		
090.2 Artikelnr./ partno.177741		
Rohr R-A-150 Tube R-A-150		
090.3 Artikelnr./ partno.177758		
Rohr R-A-200 Tube R-A-200		
090.4 Artikelnr./ partno.177766		
Rohr R-A-250 Tube R-A-250		
090.5 Artikelnr./ partno.177774		
Rohr R-A-300 Tube R-A-300		

Artikelgruppe 90
 prod.group 90

090.6 Artikelnr./ partno.179077		
Rohrenddüse RD-A-10 Nozzle for tube RD-A-10		
090.7 Artikelnr./ partno.301522		
Rohrenddüse RD-A-04 Nozzle for tube RD-A-04		
090.8 Artikelnr./ partno.302118		
Rohrenddüse RD-A-B Nozzle for tube RD-A-B		
090.9 Artikelnr./ partno.306598		
Verschluss für Sprührohr AM RD-A-V blind plug RD-A-V		
090.10 Artikelnr./ partno.800282		
Umlenkung 90° für Rohrenddüse RD-A, komplett Direction change 90° for nozzle for tube RD-A, complete		







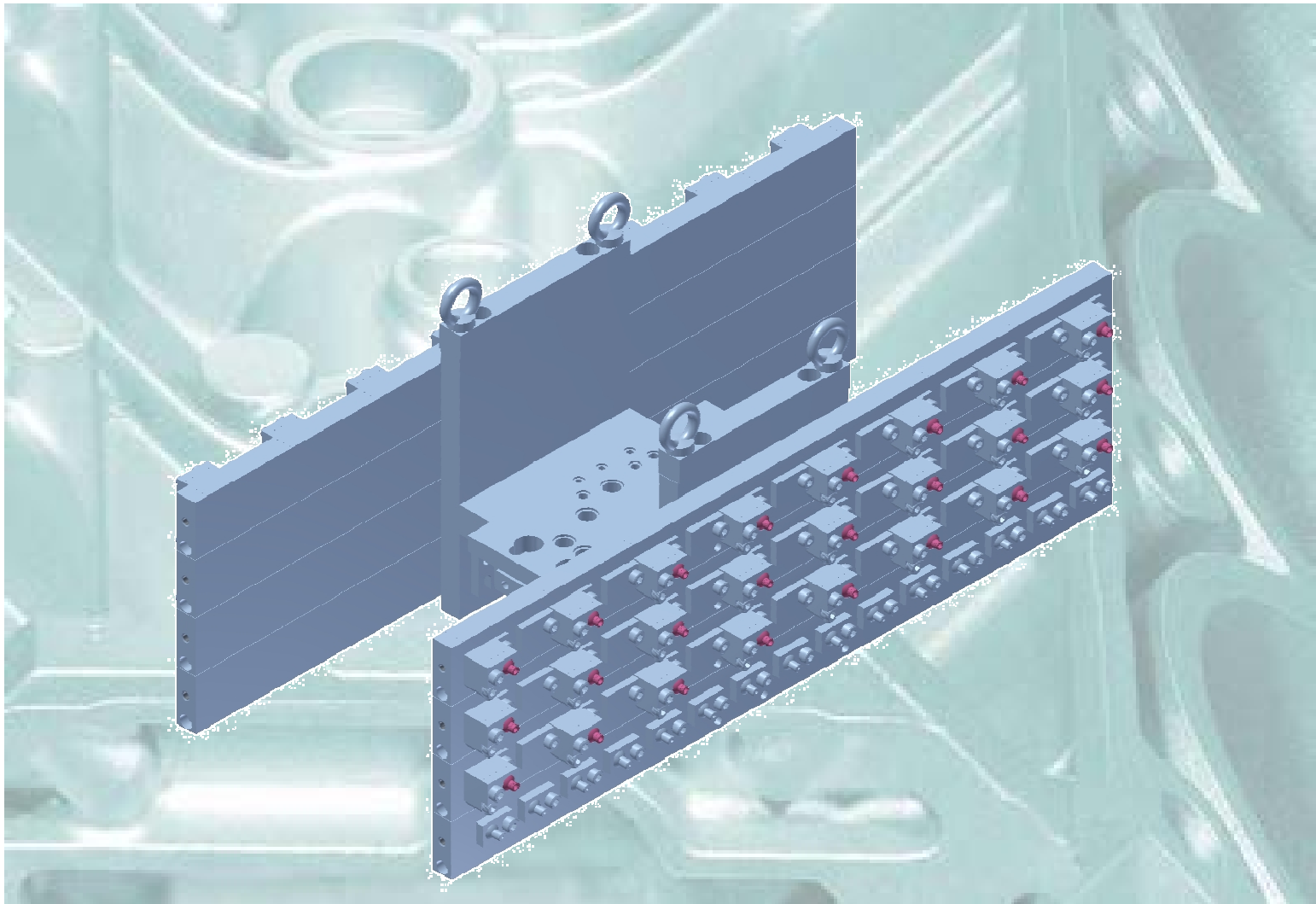



Artikelgruppe 90
 prod.group 90

090.11 Artikelnr./ partno.801055		
<p>T-Umlenkung für Rohrenddüse RD-A, komplett T-direction change for nozzle for tube RD-A; complete</p>		
090.12 Artikelnr./ partno.801058		
<p>L-Umlenkung für Rohrenddüse RD-A, komplett L-direction change for nozzle for tube RD-A; complete</p>		
090.13 Artikelnr./ partno.801060		
<p>Rohrenddüse RD-A-06 Nozzle for tube RD-A-06</p>		











Artikelgruppe 91 prod.group 91





Artikelgruppe 91
prod.group 91

091.1 Artikelnr./ partno.177709		
Kugeldüse KD-A-06 Ball nozzle KD-A-06		
091.2 Artikelnr./ partno.177717		
Kugeldüse KD-A-B-60° / Mittel 1xø0,4 / 6xø0,6 Ball nozzle KD-A-B-60° / fluid 1xø0,4 / 6xø0,6		
091.3 Artikelnr./ partno.177725		
Kugeldüse KD-A-F Ball nozzle KD-A-F		
091.4 Artikelnr./ partno.177824		
Kugeldüse KD-A-08 Ball nozzle KD-A-08		
091.5 Artikelnr./ partno.177832		
Kugeldüse KD-A-10 Ball nozzle KD-A-10		

Artikelgruppe 91
prod.group 91

091.6 Artikelnr./ partno.301933		
Kugeldüse KD-A-04 Ball nozzle KD-A-04		
091.7 Artikelnr./ partno.302383		
Kugeldüse KD-A-06-S (Verstellbereich 120°) Ball nozzle KD-A-06-S (adjusting range 120°)		
091.8 Artikelnr./ partno.304146		
Kugeldüse KD-A-15 Ball nozzle KD-A-15		
091.9 Artikelnr./ partno.304147		
Kugeldüse KD-A-20 Ball nozzle KD-A-20		
091.10 Artikelnr./ partno.800400		
Kugeldüse KD-A-02 Ball nozzle KD-A-02		







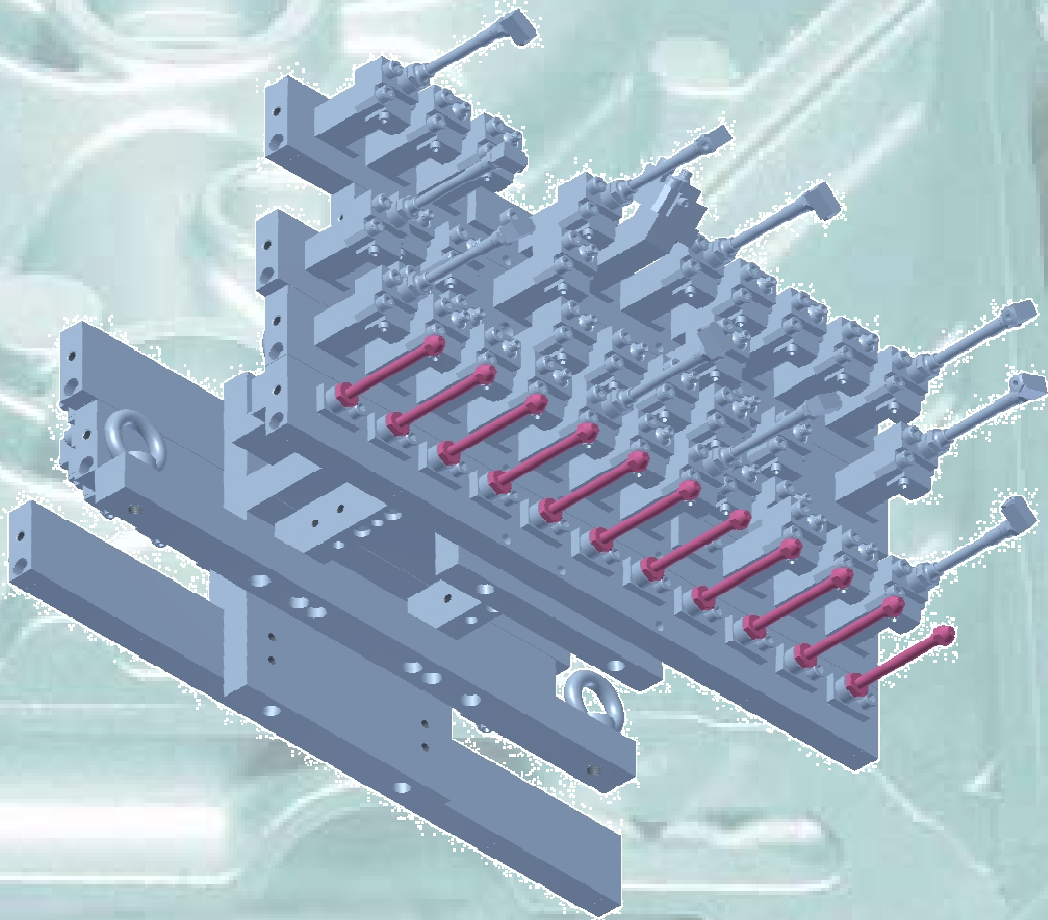

Artikelgruppe 091
prod.group 091

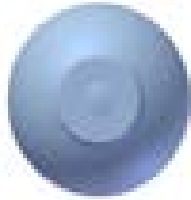
091.11 Artikelnr./ partno.800635		
Kugeldüse KD-A-06-S (Verstellbereich 180°) Ball nozzle KD-A-06-S (adjusting range 180°)		







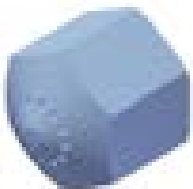



Artikelgruppe 92 prod.group 92













Artikelgruppe 92
 prod.group 92

092.1 Artikelnr./ partno.129643		
Kugeldüse KD-I-26 Ball nozzle KD-I-26		
092.2 Artikelnr./ partno.129650		
Rohr R-IB-150 Tube R-IB-150		
092.3 Artikelnr./ partno.137273		
Rohr R-IB-100 Tube R-IB-100		
092.4 Artikelnr./ partno.137695		
Rohrenddüse RD-I-F Nozzle for tube RD-I-F		
092.5 Artikelnr./ partno.137703		
Rohrenddüse RD-I-B Nozzle for tube RD-I-B		











Artikelgruppe 92
prod.group 92

092.6 Artikelnr./ partno.138701		
Rohr R-IB-200 Tube R-IB-200		
092.7 Artikelnr./ partno.138719		
Rohr R-IB-250 Tube R-IB-250		
092.8 Artikelnr./ partno.138727		
Rohr R-IB-300 Tube R-IB-300		
092.9 Artikelnr./ partno.143768		
Kugeldüse KD-I-F Ball nozzle KD-I-F		
092.10 Artikelnr./ partno.144097		
Rohrenddüse RD-I-26 Nozzle for tube RD-I-26		











Artikelgruppe 92
 prod.group 92

092.11 Artikelnr./ partno.144105		
Rohr R-IB-60 Tube R-IB-60		
092.12 Artikelnr./ partno.144113		
Kugeldüse KD-I-26-S (Verstellb. 120°) Ball nozzle KD-I-26-S (range 120°)		
092.13 Artikelnr./ partno.144121		
Kugeldüse KD-I-26-S (Verstellb. 180°) Ball nozzle KD-I-26-S (range 180°)		
092.14 Artikelnr./ partno.144139		
Kugeldüse KD-I-B Ball nozzle KD-I-B		
092.15 Artikelnr./ partno.305887		
Rohr R-IB-60 ohne Düsengewinde Tube R-IB-60 without thread		











Artikelgruppe 92
prod.group 92

092.16 Artikelnr./ partno.305888		
Rohr R-IB-100 ohne Düsengewinde Tube R-IB-100 without threat		
092.17 Artikelnr./ partno.305889		
Rohr R-IB-150 ohne Düsengewinde Tube R-IB-150 without threat		
092.18 Artikelnr./ partno.305890		
Rohr R-IB-200 ohne Düsengewinde Tube R-IB-200 without threat		
092.19 Artikelnr./ partno.305891		
Rohr R-IB-250 ohne Düsengewinde Tube R-IB-250 without threat		
092.20 Artikelnr./ partno.305892		
Rohr R-IB-300 ohne Düsengewinde Tube R-IB-300 without threat		

Artikelgruppe 92
 prod.group 92

092.21 Artikelnr./ partno.800383		
Umlenkung 90° für Rohrenddüse RD-I, komplett Direction change 90° for nozzle for tube RD-I, complete		
092.22 Artikelnr./ partno.801078		
Kugeldüse KD-I-10 Ball nozzle KD-I-10		
092.23 Artikelnr./ partno.801079		
Kugeldüse KD-I-15 Ball nozzle KD-I-15		
092.24 Artikelnr./ partno.801255		
Kugeldüse KD-I-30 Ball nozzle KD-I-30		
092.25 Artikelnr./ partno.801374		
Kugeldüse KD-I-20 Ball nozzle KD-I-20		

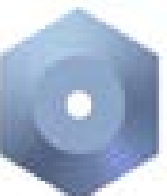

Artikelgruppe 92
prod.group 92

092.26 Artikelnr./ partno.801407		
Rohrenddüse RD-I-B / 6 x Ø1,5mm Nozzle for tube RD-I-B / 6xØ1,5mm		
092.27 Artikelnr./ partno.801491		
Rohrenddüse RD-I-30 Nozzle for tube RD-I-30		
092.28 Artikelnr./ partno.801493		
Rohrenddüse RD-I-35 Nozzle for tube RD-I-35		
092.29 Artikelnr./ partno.801495		
Rohrenddüse RD-I-40 Nozzle for tube RD-I-40		
092.30 Artikelnr./ partno.801503		
Rohrenddüse RD-I-20 Nozzle for tube RD-I-20		

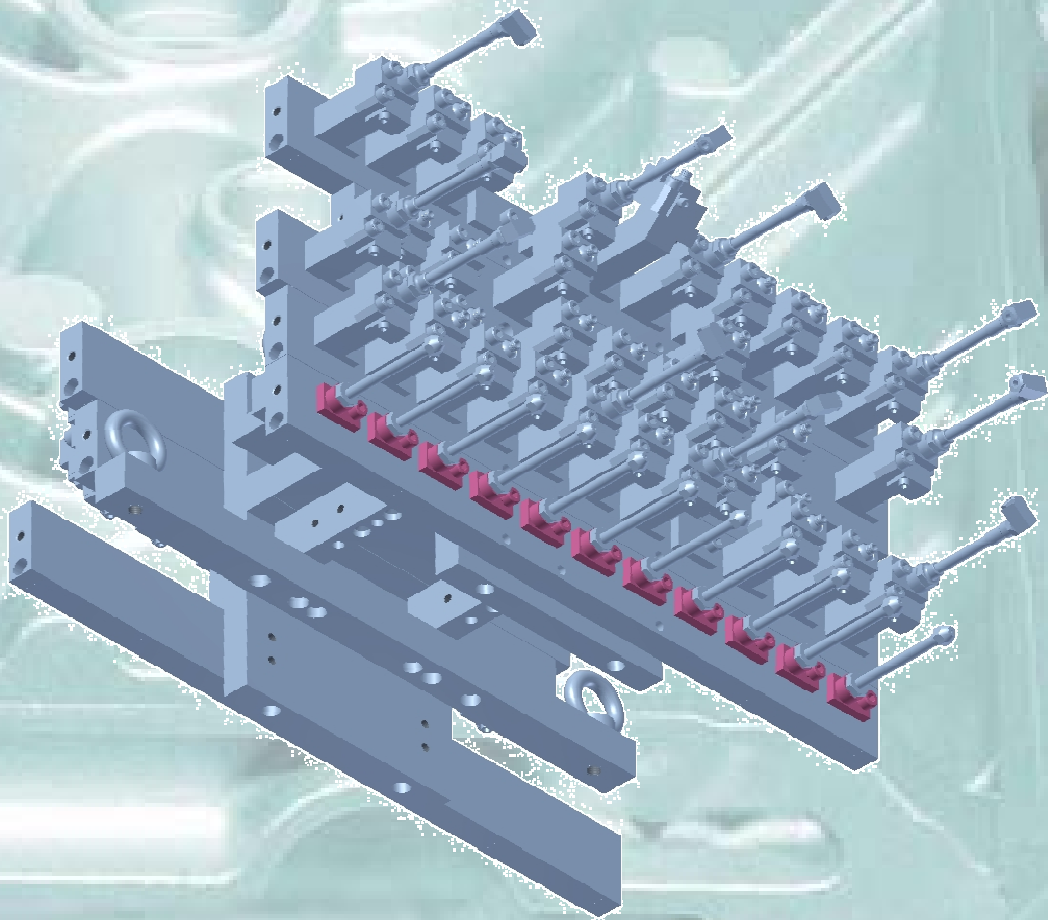
Artikelgruppe 93 prod.group 93





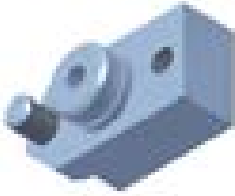



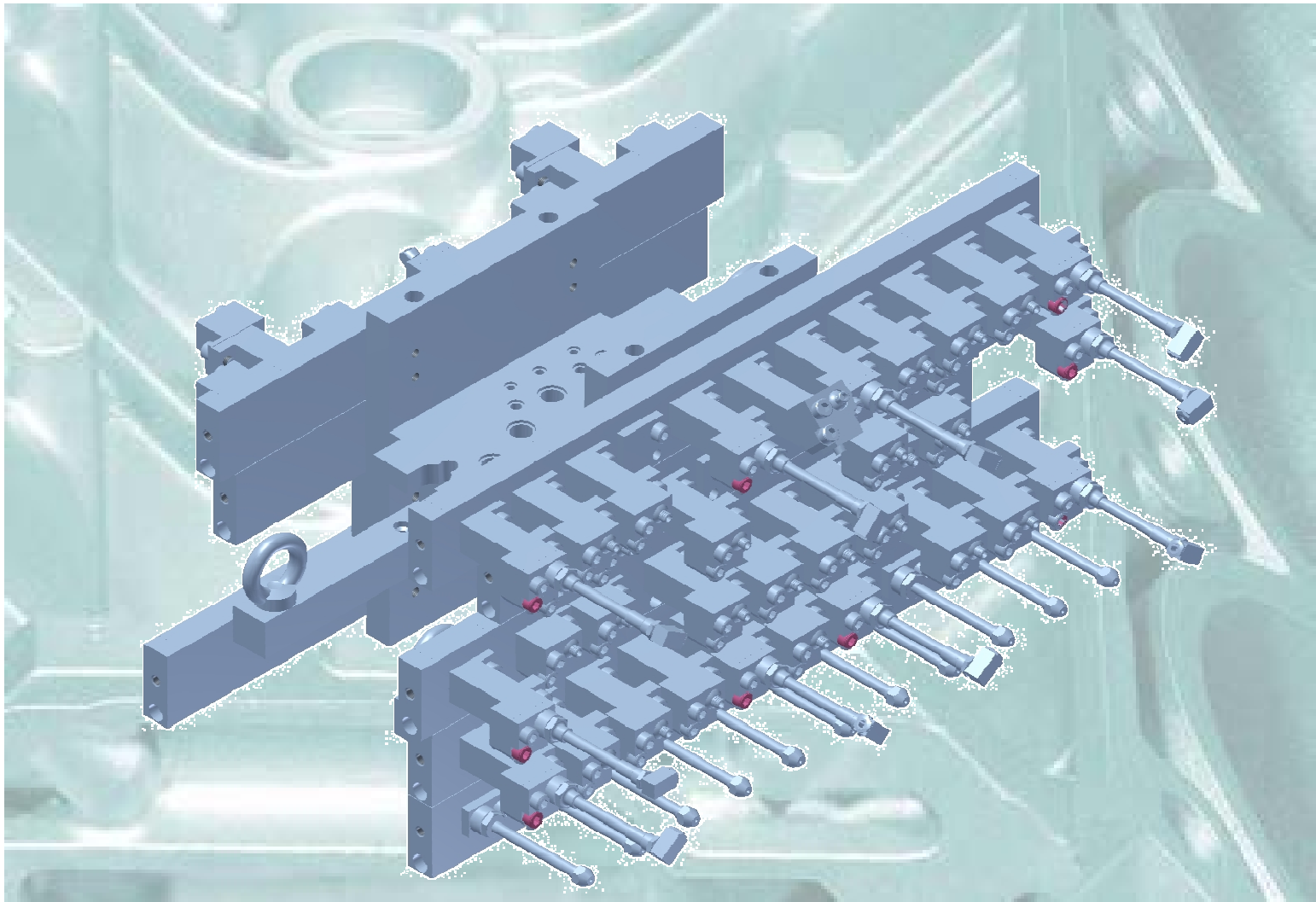



Artikelgruppe 93
prod.group 93

093.1 Artikelnr./ partno.179564		
Halteplatte für Rohr auf Blasteiste mit Schraube M8, rechteckig, komplett Holding plate for tube on a blasting strip		
093.2 Artikelnr./ partno.323017		
Rückschlagventil für Blasset PS16, komplett check valve for blast. set		











Artikelgruppe 94 prod.group 94



Artikelgruppe 94
prod.group 94

094.1 Artikelnr./ partno.135913		
Dosierblende DB-1-06 Dosing insert DB-1-06		
094.2 Artikelnr./ partno.135939		
Dosierblende DB-0-04 Dosing insert DB-0-04		
094.3 Artikelnr./ partno.135954		
Dosierblende DB-2-08 Dosing insert DB-2-08		
094.4 Artikelnr./ partno.135970		
Dosierblende DB-3-10 Dosing insert DB-3-10		
094.5 Artikelnr./ partno.135996		
Dosierblende DB-4-12 Dosing insert DB-4-12		







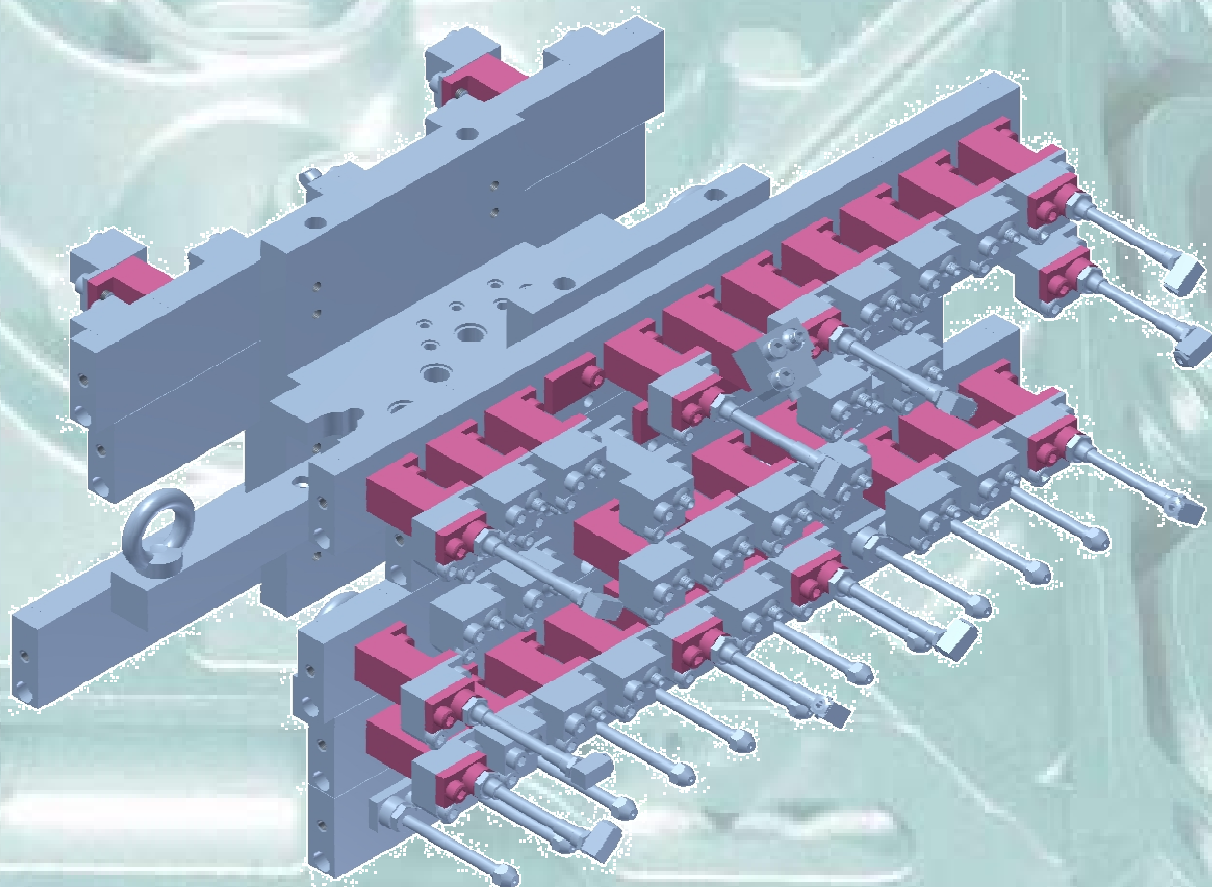

Artikelgruppe 94
prod.group 94

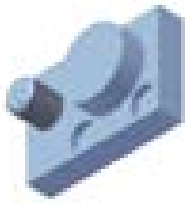
094.6 Artikelnr./ partno.136150		
Dosierblende DB-6-20 Dosing insert DB-6-20		
094.7 Artikelnr./ partno.138073		
Dosierblende DB-5-16 Dosing insert DB-5-16		
094.8 Artikelnr./ partno.194142		
Dosierblende DB-E Dosing insert DB-E		
094.9 Artikelnr./ partno.801403		
Dosierblende DB-0-01 Dosing insert DB-0-01		
094.10 Artikelnr./ partno.801405		
Dosierblende DB-0-02 Dosing insert DB-0-02		





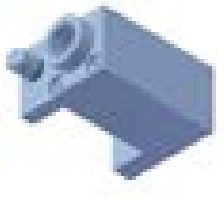





Artikelgruppe 95 prod.group 95



Artikelgruppe 95
prod.group 95

095.1 Artikelnr./ partno.129619		
Verschuß (Blindplatte Sprüh-/Blasdüse) mit Schraube M8, rechteckig, komplett Cover plate with screw and O-ring		
095.2 Artikelnr./ partno.156869		
Klemmdeckel für Kugeldüse mit Schraube M8, rechteckig, komplett Clamp plate for ball nozzle with screw M8 and O-ring, rectangular		
095.3 Artikelnr./ partno.245084		
Halteplatte für Rohr mit Schraube M8, rechteckig, komplett Holding plate for tube on a nozzle		
095.4 Artikelnr./ partno.250191		
Sprüh-/Blasdüsenerhöhung 50mm PS16, komplett Spray and blasting nozzle extension 50mm PS16, complete		
095.5 Artikelnr./ partno.250209		
Sprüh-/Blasdüsenerhöhung, schwenkbar PS16/PS16C, komplett Rotatable spray and blasting nozzle extension PS16/PS16C, complete		



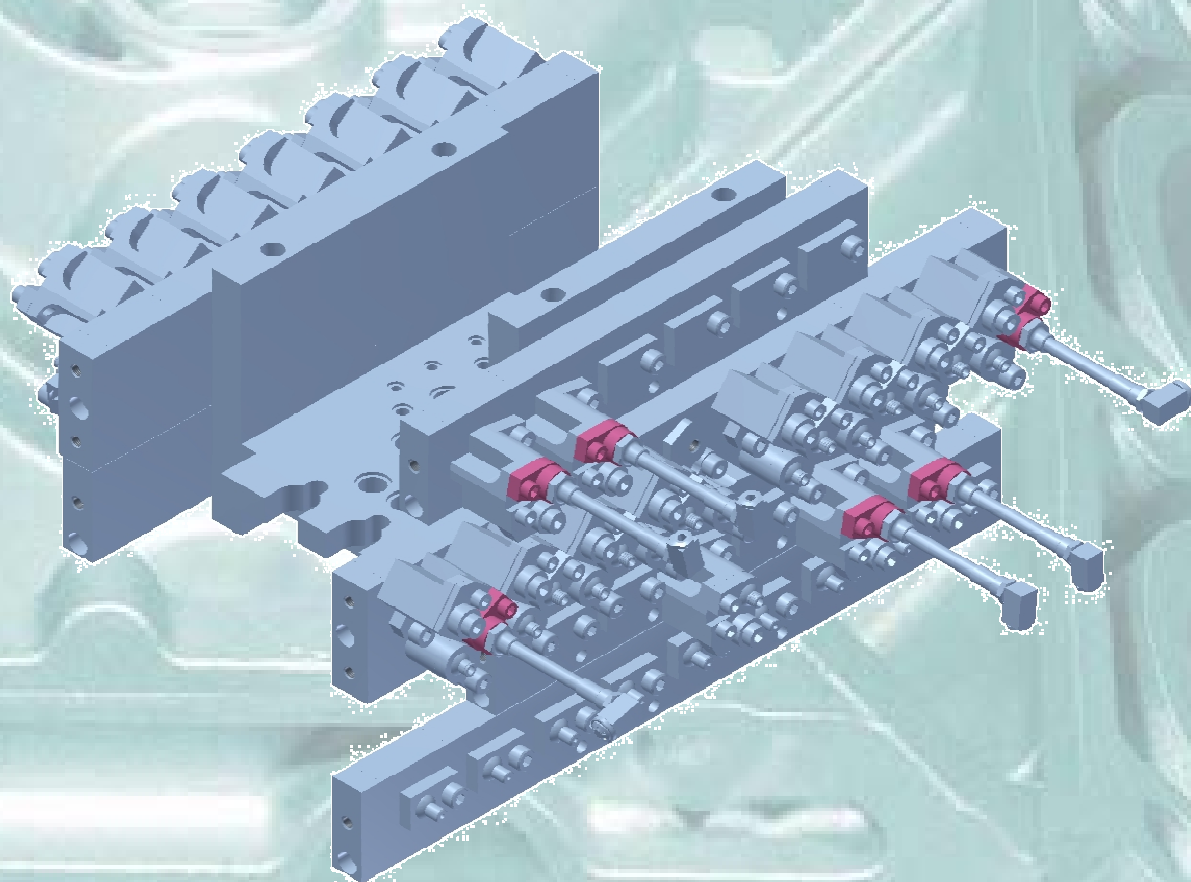

Artikelgruppe 95
 prod.group 95

<p>095.6 Artikelnr./ partno.250415</p> <p>Sprüh-/Blasdüsenerhöhung 100mm PS16, komplett</p> <p>Spray and blasting nozzle extension 100mm PS16, complete</p>		
<p>095.7 Artikelnr./ partno.301725</p> <p>Sprüh-/Blasdüsenerhöhung 45° links PS16, komplett</p> <p>Spray and blasting nozzle extension 45° left PS16, complete</p>		
<p>095.8 Artikelnr./ partno.301726</p> <p>Sprüh-/Blasdüsenerhöhung 45° rechts PS16, komplett</p> <p>Spray and blasting nozzle extension 45° right PS16, complete</p>		
<p>095.9 Artikelnr./ partno.800405</p> <p>Sprüh-/Blasdüsenerhöhung 45° oben PS16, komplett</p> <p>Spray and blasting nozzle extension 45° above PS16, complete</p>		
<p>095.10 Artikelnr./ partno.800406</p> <p>Sprüh-/Blasdüsenerhöhung 45° unten PS16, komplett</p> <p>Spray and blasting nozzle extension 45° down PS16, complete</p>		

Artikelgruppe 97 prod.group 97



Artikelgruppe 97
prod.group 97





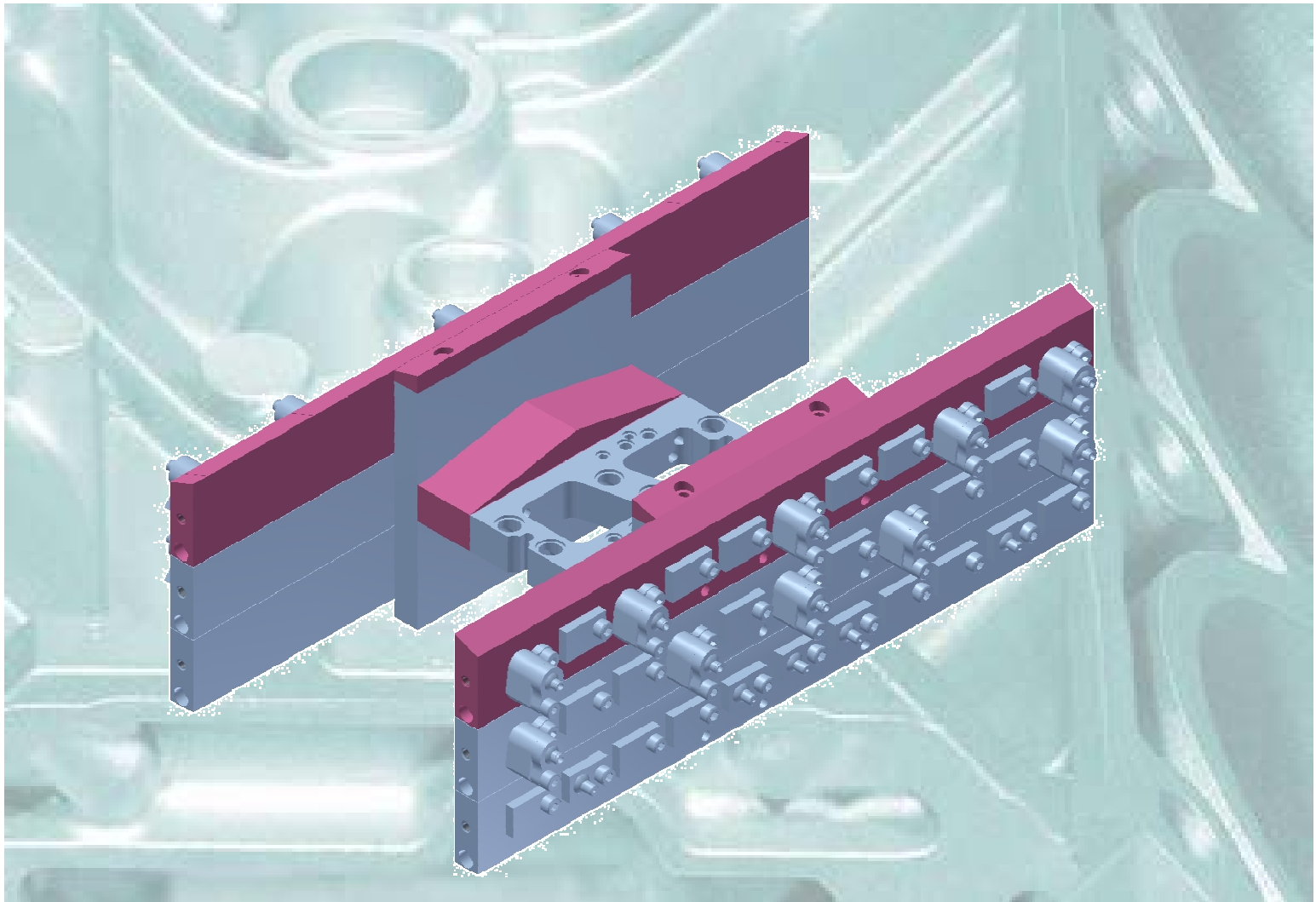





097.1 Artikelnr./ partno.244822		
Halteplatte für Rohr mit Schraube M6, gerundet, komplett Holding plate for spraying tube (M6 screw)		
097.2 Artikelnr./ partno.244830		
Klemmdeckel für Kugeldüse mit Schraube M6, gerundet, komplett Clamp plate for ball nozzle with screw M6 and O-ring, rounded		

Artikelgruppe 100 Sonderteile prod.group 100 special parts













SPRÜHTECHNIK – PRODUKTKATALOG PS16
SPRAY TECHNOLOGY – PRODUCT CATALOG PS16

Artikelgruppe 100 Sonderteile
prod.group 100 special parts

100.1 Artikelnr./ partno.800813		
Adaptermodul 50mm PS16-6, komplett (mit Schräge) Adaptor module 50mm PS16-6, complete (with slant)		
100.2 Artikelnr./ partno.800910		
Sprühleiste 250mm Kreis 5/6 PS16-6/8, komplett (mit Schräge) Spray strip 250mm circuit 5/6 PS16-6/8, complete (with slant)		
100.3 Artikelnr./ partno.800912		
Sprüh-/Blasleistenmodul 100mm PS16, komplett (mit Schräge) Spray and blasting strip module 100mm PS16, complete (with slant)		
100.4 Artikelnr./ partno.800914		
Sprüh-/Blasleistenmodul 50mm PS16, komplett (mit Schräge) Spray and blasting strip module 50mm PS16, complete (with slant)		
100.5 Artikelnr./ partno.800916		
Sprühleiste 350mm Kreis 3/4 PS16-6/8, komplett (mit Schräge) Spray strip 350mm circuit 3/4 PS16-6/8, complete (with slant)		











SPRÜHTECHNIK – PRODUKTKATALOG PS16
SPRAY TECHNOLOGY – PRODUCT CATALOG PS16

Artikelgruppe 100 Sonderteile
prod.group 100 special parts









100.6 Artikelnr./ partno.800917		
Sprüh-/Blasleistenschliessleiste L PS16, komplett, ohne O-Ringe (mit Schräge) Cover for spray and blasting strip L PS16, comp., left without o-rings (with slant)		
100.7 Artikelnr./ partno.800919		
Sprüh-/Blasdüsenerhöhung 100mm PS16, komplett (mit Schräge) Spray and blasting nozzle extension 100mm PS16-6, complete (with slant)		
100.8 Artikelnr./ partno.800920		
Sprüh-/Blasabschlußleiste 100mm links PS16, komplett (mit Schräge) Left end spray and blasting strip module 100mm PS16, complete (with slant)		
100.9 Artikelnr./ partno.800922		
Sprüh-/Blasdüsenerhöhung 50mm PS16, komplett (mit Schräge) Spray and blasting nozzle extension 50mm PS16-6, complete (with slant)		
100.10 Artikelnr./ partno.800924		
Sprüh-/Blasdüsenerhöhung 45° oben PS16, komplett (mit Schräge) Spray and blasting nozzle extension 45° above PS16-6, complete (with slant)		

SPRÜHTECHNIK – PRODUKTKATALOG PS16
SPRAY TECHNOLOGY – PRODUCT CATALOG PS16

Artikelgruppe 100 Sonderteile
prod.group 100 special parts

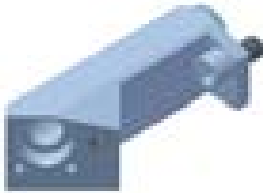
100.11 Artikelnr./ partno.800926		
Sprühleiste 350mm Kreis 1/2 PS16-6/8, komplett (mit Schräge) Spray strip 350mm circuit 1/2 PS16-6/8, complete (with slant)		
100.12 Artikelnr./ partno.800928		
Sprüh-/Blasleistenschliessleiste R PS16, komplett, mit O-Ringen (mit Schräge) Cover for spray and blasting strip R PS16, comp., right without o-rings (with slant)		
100.13 Artikelnr./ partno.800931		
Sprüh-/Blasdüsenerhöhung 45° unten PS16, komplett (mit Schräge) Spray and blasting nozzle extension 45° down PS16-6, complete (with slant)		
100.14 Artikelnr./ partno.800936		
Sprühdüse SD13 SD-A-03+KD-A-10 (mit Schräge) Spray nozzle SD13 SD-A-03+KD-A-10		
100.15 Artikelnr./ partno.800939		
Verteilerschließplatte O PS16-6, komplett, ohne O-Ringe (mit Schräge) Endplate upside PS16-6, complete (en biais)		







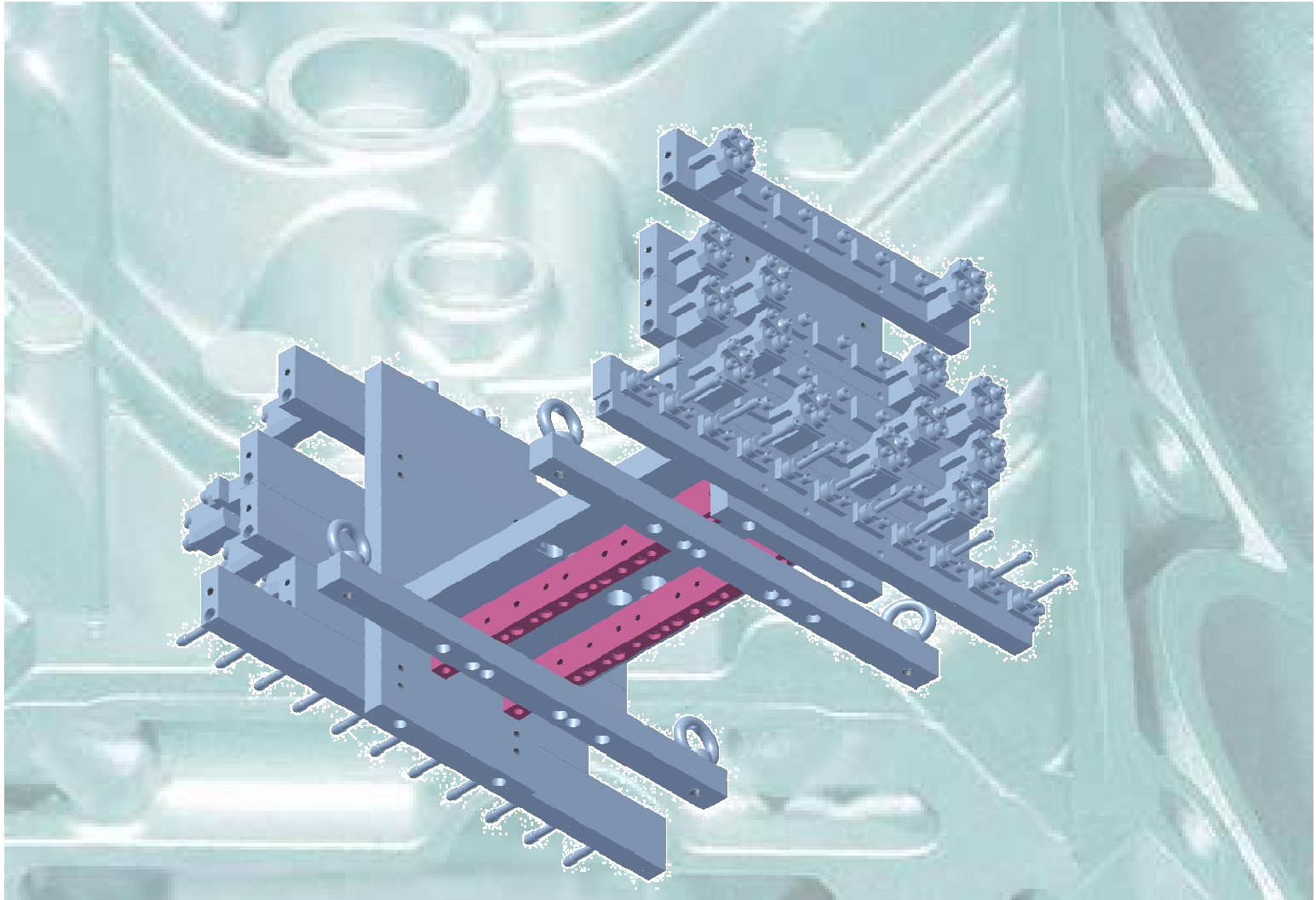



Artikelgruppe 100 Sonderteile
 prod.group 100 special parts

100.16 Artikelnr./ partno.801049		
Adaptermodul 25mm PS16/PS16C-6, komplett (schräg) Adaptor module 25mm PS16/PS16C-6, complete		
100.17 Artikelnr./ partno.801051		
Sprüh-/Blasdüsenerhöhung 45° links PS16, komplett (mit Schräge) Spray and blasting nozzle extension 45° left PS16-6, complete (with slant)		
100.18 Artikelnr./ partno.801053		
Sprüh-/Blasdüsenerhöhung 45° rechts PS16, komplett (mit Schräge) Spray and blasting nozzle extension 45° right PS16-6, complete (with slant)		
100.19 Artikelnr./ partno.801385		
Verteilerschließplatte U PS16-6, komplett, mit Mittelanschluss Distributor cover below PS16-6, complete, without O-rings		











Artikelgruppe 110 Handling, Versteifung, etc. prod.group 110 handling / strengthening / etc





Artikelgruppe 110 Handling, Versteifung, etc.
 prod.group 110 handling / strengthening / etc

110.1 Artikelnr./ partno.800656		
Verstärkungsleiste Länge : 300 mm Reinforcing strip length = 300 mm		
110.2 Artikelnr./ partno.800664		
Verstärkungsleiste Länge : 400 mm Reinforcing strip length = 400 mm		
110.3 Artikelnr./ partno.800665		
Verstärkungsleiste Länge : 500 mm Reinforcing strip length = 500 mm		
110.4 Artikelnr./ partno.800772		
Verstärkungsleiste Länge : 250 mm Reinforcing strip length = 250 mm		
110.5 Artikelnr./ partno.800850		
Verstärkungsleiste Länge : 260 mm /unsymetr. Reinforcing strip length = 260 mm		

Artikelgruppe 110 Handling, Versteifung, etc.
 prod.group 110 handling / strengthening / etc

110.6 Artikelnr./ partno.800899		
Befestigungsleiste für Versteifung B=226mm attachment strip for reinforcing B= 226mm		
110.7 Artikelnr./ partno.800929		
Befestigungsleiste für Versteifung B=350mm attachment strip for reinforcing B= 350mm		
110.8 Artikelnr./ partno.800967		
Verstärkungsleiste Länge : 225 mm Reinforcing strip length = 225 mm		
110.9 Artikelnr./ partno.801061		
Befestigungsleiste für Versteifung B=300mm attachment strip for reinforcing B= 300mm		
110.10 Artikelnr./ partno.801144		
Verstärkungsleiste Länge : 600 mm Reinforcing strip length = 600 mm		







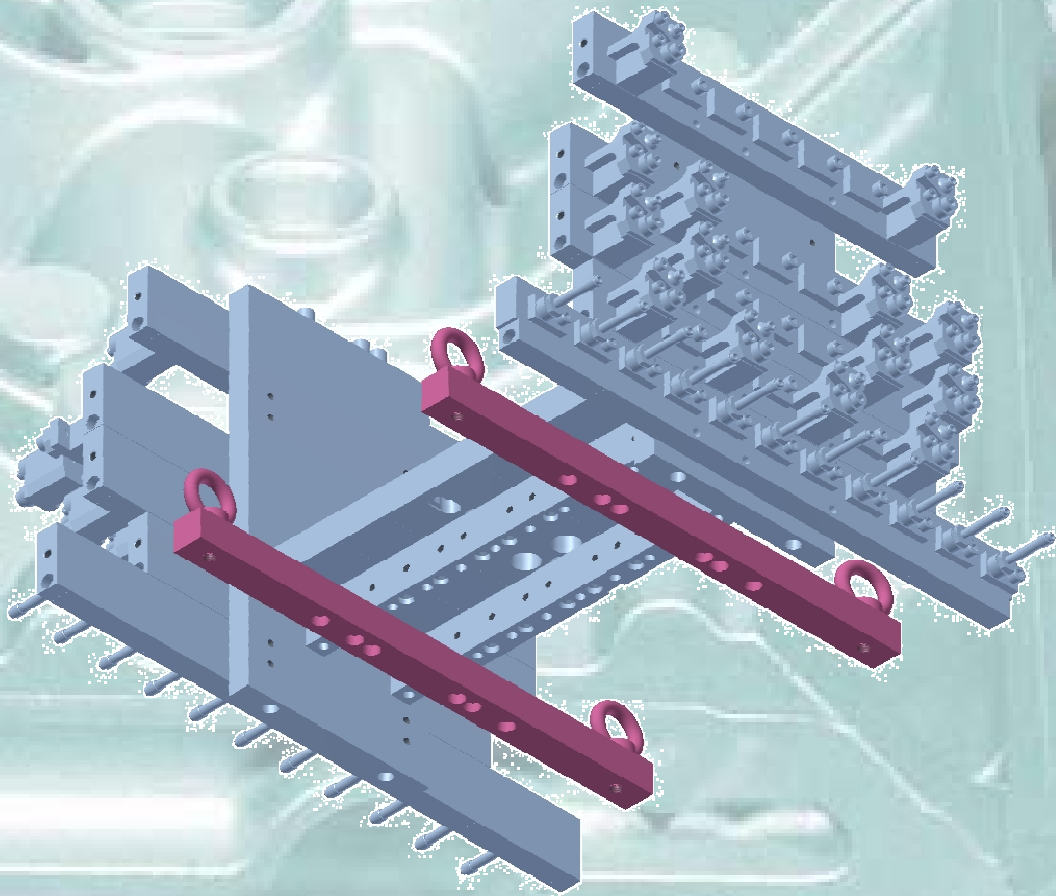



Artikelgruppe 110 Handling, Versteifung, etc.
 prod.group 110 handling / strengthening / etc

110.11 Artikelnr./ partno.801343		
Verstärkungsleiste Länge : 180 mm Reinforcing strip length = 180 mm		
110.12 Artikelnr./ partno.801509		
Befestigungsleiste für Versteifung B=450mm attachment strip for reinforcing B= 450mm		
110.13 Artikelnr./ partno.801513		
Verstärkungsleiste Länge : 700 mm Reinforcing strip length = 700 mm		
110.14 Artikelnr./ partno.801735		
Verstärkungsleiste Länge : 160 mm Reinforcing strip length = 160 mm		











Artikelgruppe 120 Zubehör prod.group 120 addons





Artikelgruppe 120 Zubehör
 prod.group 120 addons

<p>120.1 Artikelnr./ partno.22806</p> <p>Ringschraube C15E M12 DIN580 verzinkt eye bolt C15E M12 DIN580 zinc coated</p>		
<p>120.2 Artikelnr./ partno.301749</p> <p>Düsenjustiergerät mit Laserpointer Nozzle adjustment unit with Laser</p>		
<p>120.3 Artikelnr./ partno.325054</p> <p>Flachstange 20x5mm ALU, natur eloxiert, Meterware flat bar 20x5mm aluminium, anodized, sold by metre</p>		
<p>120.4 Artikelnr./ partno.800638</p> <p>Befestigungsklotz Versteifungsleiste PS16-8/PS16-4 chock hardening strip PS16-8/PS16-4</p>		
<p>120.5 Artikelnr./ partno.800783</p> <p>Querleiste Anhängemöglichkeit für SWZ, Länge =500mm Cross strip for lift the tool length = 500 mm</p>		

Artikelgruppe 120 Zubehör
 prod.group 120 addons

120.6 Artikelnr./ partno.800977		
Befestigungsklotz Versteifungsleiste PS16-6 chock hardening strip PS16-6		
120.7 Artikelnr./ partno.801088		
Querleiste Anhängemöglichkeit für SWZ, Länge =700mm Cross strip for lift the tool length = 700 mm		
120.8 Artikelnr./ partno.801214		
Leiste für Transportpalette, PS16-8 Strip for transport rack; PS16-8		
120.9 Artikelnr./ partno.801381		
Leiste für Transportpalette, PS16-6 Strip for transport rack PS16-6		
120.10 Artikelnr./ partno.801462		
Leiste für Transportpalette, PS16-6, sonder Strip for transport rack PS16-6		

Artikelgruppe 120 Zubehör
prod.group 120 addons

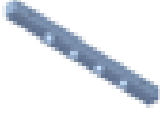
120.11 Artikelnr./ partno.801479		
Leiste für Transportpalette, PS16-8 (L=600mm) Strip for transport rack PS16-8		
120.12 Artikelnr./ partno.801512		
Leiste für Transportpalette, Befestigung auf Sprühleisten Strip for transport rack		

Inhaltsverzeichnis Table of Contents

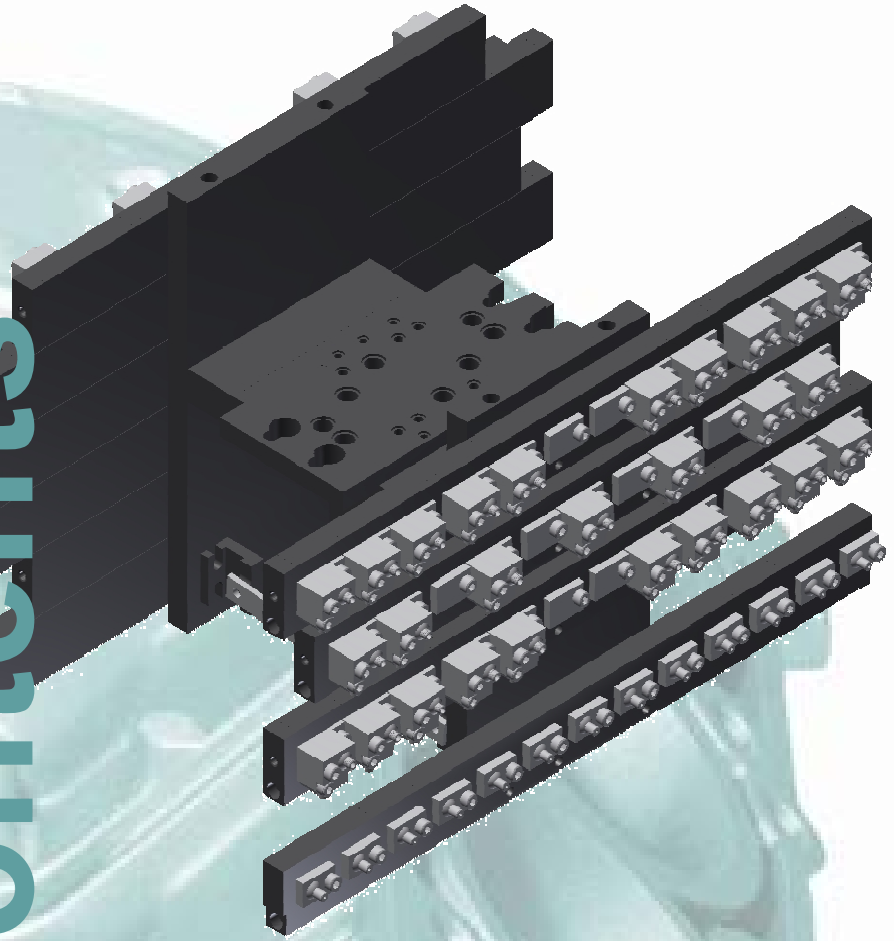

SPRÜHTECHNIK – PRODUKTKATALOG PS16
SPRAY TECHNOLOGY – PRODUCT CATALOG PS16

Artikelgruppe 000 Zwischenadapter
prod.group 000 intermediate adaptor

Pos	Beschreibung	Seite	Pos	description	Page
000.1	Zwischenadapter	3	000.1	intermediate adaptor	3
000.2	Zwischenadapter PS16-4/PSM2	3	000.2	intermediate adaptor PS16-4/PSM2	3
000.3	Spezialverteilerplatte	3	000.3	Special-distributor plate	3
000.4	Zwischenadapter PS16/PSM224	3	000.4	Intermediate adaptor PS16/PSM224	3
000.5	Zwischenadapter	3	000.5	intermediate adaptor PS16/PSM2	3
000.6	Zwischenplatte 8 zu 6Kreis	4	000.6	Intermediateplate 8 to 6	4
000.7	Spezialverteilerplatte	4	000.7	Special-distributor plate	4
000.8	Zwischenadapter Wollin an IDRA	4	000.8	Intermediate adaptor	4

Artikelgruppe 010 Adapter
prod.group 010 adaptor

Pos	Beschreibung	Seite	Pos	description	Page
010.1	Adapter PS16-6/SM-4Kreis/PSM-4Kreis	6	010.1	Adaptor PS16 - SM 4 circuit	6
010.2	Adapter PS16-6/PSM324/PSM336/PSM436	6	010.2	Adaptor PS16-6/PSM324/PSM336/PSM436	6
010.3	Adapter PS16/SM-2Kreis	6	010.3	Adaptor PS16/SM2 circuit	6
010.4	Adapter PS16-8/PSM448	6	010.4	Adaptor PS16-8/PSM448	6
010.5	Adapter PS16-6/PSM224	6	010.5	Adaptor PS16-6/PSM224	6
010.6	Adapter PS16-8/PSM448	7	010.6	Adaptor PS16-8/PSM448	7
010.7	Adapter PS16-6/PSM324-6/PSM336/PSM436/PSM3, schmal	7	010.7	Adaptor, narrow	7
010.8	Adapter PS16/PSM2	7	010.8	Adaptor PS16/PSM2	7
010.9	Adapter B3/F2 PS16/PSM2	7	010.9	Adaptor B3/F2 PS16/PSM2	7
010.10	Adapter PS16/PSM1	7	010.10	Adaptor PS16-6/PSM1	7
010.11	Adapter PS16/PSM2, schmal	8	010.11	Adaptor PS16/PSM2, narrow	8
010.12	Adapter PS16/PSM2	8	010.12	Adaptor PS16/PSM2	8

Artikelgruppe 011 Adaptermodule
prod.group 011 adaptor module

Pos	Beschreibung	Seite	Pos	description	Page
011.1	Adaptermodul 50mm	10	011.1	Adaptor module 50mm	10
011.2	Adaptermodul 25mm	10	011.2	Adaptor module 25mm	10
011.3	Adaptermodul 50mm	10	011.3	Adaptor module 50mm	10

SPRÜHTECHNIK – PRODUKTKATALOG PS16
SPRAY TECHNOLOGY – PRODUCT CATALOG PS16

Artikelgruppe 011 Adaptermodule
prod.group 011 adaptor module

Pos	Beschreibung	Seite	Pos	description	Page
011.4	Adaptermodul 25mm	10	011.4	Adaptor module 25mm	10
011.5	Adaptermodul 25mm, 90° gedreht	10	011.5	Adaptor module 25mm, 90° turned	10
011.6	Adaptermodul 50mm (>300)	11	011.6	Adaptor module 50mm (>300)	11
011.7	Adaptermodulabzweigung	11	011.7	Adaptor module junction	11
011.8	Adapterschliessleiste	11	011.8	Cover for adaptor	11
011.9	Adaptermodul 50mm, 90° gedreht	11	011.9	Adaptor module 50mm, turned 90°	11
011.10	Adaptermodul 50mm (>300)	11	011.10	Adaptor module 50mm (>300)	11
011.11	Adaptermodul 25mm, 90° gedreht	12	011.11	Adaptor module 25mm, 90° turned	12

Artikelgruppe 020 Verteilung Erweiterungen
prod.group 020 distibution additionalns

Pos	Beschreibung	Seite	Pos	description	Page
020.1	Verteilerumlenkung HO	14	020.1	Distributor deflection HO	14
020.2	Verteilerumlenkung HU	14	020.2	Distributor deflection HU	14
020.3	Verteilerdistanzmodul 60mm	14	020.3	Distribution distance module 60mm	14
020.4	Verteilerdistanzmodul 20mm	14	020.4	Distribution distance module 20mm	14
020.5	Verteilerschließplatte U	14	020.5	Distributor cover below	14
020.6	Verteilerschließplatte O	15	020.6	Distributor cover above	15
020.7	Verteilerschließplatte U	15	020.7	Distributor cover below	15
020.8	Verteilerschließplatte O	15	020.8	Distributor cover above	15
020.9	Verteilerdistanzmodul 60mm	15	020.9	Distribution distance module 60mm	15
020.10	Verteilerdistanzmodul 20mm	15	020.10	Distribution distance module 20mm	15
020.11	Verteilerumlenkung HO	16	020.11	Distributor deflection HO	16
020.12	Verteilerumlenkung HU	16	020.12	Distributor deflection HU	16
020.13	Verteileranschlußleiste	16	020.13	Distribution connection strip	16
020.14	Verteileranschlußleiste	16	020.14	Distribution connection strip	16
020.15	Verteilerumlenkung 45° VO	16	020.15	Distributor deflection 45° VO	16
020.16	Verteilerumlenkung 45° VU	17	020.16	Distributor deflection 45° VU	17
020.17	Verteilerumlenkung 45° VO	17	020.17	Distributor deflection 45° VU	17
020.18	Verteilerumlenkung 45° VU	17	020.18	Distributor deflection 45° VU	17
020.19	Verteilerumlenkung 45° HU	17	020.19	Distributor deflection 45° HU	17
020.20	Verteilerumlenkung 45° HO	17	020.20	Distributor deflection 45° HO	17
020.21	Verteilerumlenkung 45° HO	18	020.21	Distributor deflection 45° HO	18
020.22	Verteilerumlenkung 45° HU	18	020.22	Distributor deflection 45° HU	18
020.23	Verteilerdistanzmodul 15mm	18	020.23	Distribution distance module 15mm	18
020.24	Verteilerumlenkung VU mit Durchgang	18	020.24	Distributor deflection VU with pass	18
020.25	Verteilerumlenkung VO mit Durchgang	18	020.25	Distributor deflection VO with pass	18
020.26	Verteilerzwischenadapter	19	020.26	Distribution intermediate adaptor	19

SPRÜHTECHNIK – PRODUKTKATALOG PS16
SPRAY TECHNOLOGY – PRODUCT CATALOG PS16

Artikelgruppe 020 Verteilung Erweiterungen
prod.group 020 distribution additional

Pos	Beschreibung	Seite	Pos	description	Page
020.27	Verteilerzwischenadapter	19	020.27	Distribution intermediate adaptor	19
020.28	Verteilerumlenkung VO mit Durchgang	19	020.28	Distributor deflection VO with pass	19
020.29	Verteilerumlenkung VU mit Durchgang	19	020.29	Distributor deflection VU with pass	19
020.30	Verteilerschließplatte O	19	020.30	Distributor cover above	19
020.31	Verteilerschließplatte O	20	020.31	Distributor upper cover	20
020.32	Verteilerdistanzmodul 10mm	20	020.32	Distribution distance module 10mm	20

Artikelgruppe 021 Verteilung standard
prod.group 021 distribution standard

Pos	Beschreibung	Seite	Pos	description	Page
021.1	Verteilerleistenmodul	22	021.1	Distribution strip module	22
021.2	Verteilerleiste	22	021.2	Distribution strip	22
021.3	Verteilerleistenmodul	22	021.3	Distribution strip module	22
021.4	Verteilerleistenmodul	22	021.4	Distribution strip module	22
021.5	Verteilerleiste	22	021.5	Distribution strip	22
021.6	Verteilerleistenverschlußplatte	23	021.6	Distribution strip cover plate	23
021.7	Verteilerleistenmodul	23	021.7	Distribution strip module	23
021.8	Verteilerleistenverschlußplatte	23	021.8	Distribution strip cover plate	23
021.9	Verteilerleiste	23	021.9	distributionstrip U without closingpl.	23
021.10	Verteilerleistenmodul	23	021.10	Distribution strip module	23
021.11	Verteilerleistenmodul	24	021.11	Distribution strip module	24
021.12	Verteilerleiste	24	021.12	distributionstrip	24
021.13	Verteilerleistenmodul	24	021.13	distribution strip module	24
021.14	Verteilerleiste	24	021.14	distribution strip	24

Artikelgruppe 030 Sprüh-/Blasleisten standard
prod.group 030 spray-/blast strips standard

Pos	Beschreibung	Seite	Pos	description	Page
030.1	Sprühleiste 350mm Kreis 1/2	26	030.1	Spray strip 350mm circuit 1/2	26
030.2	Sprühleiste 350mm Kreis 3/4	26	030.2	Spray strip 350mm circuit 3/4	26
030.3	Sprühleiste 350mm Kreis 5/6	26	030.3	Spray strip 350mm circuit 5/6	26
030.4	Blasleiste 350mm	26	030.4	Blasting strip 350mm	26
030.5	Sprühleiste 250mm Kreis 3/4	26	030.5	Spray strip 250mm circuit 3/4	26
030.6	Sprühleiste 250mm Kreis 1/2	27	030.6	Spray strip 250mm circuit 1/2	27
030.7	Sprühleiste 250mm Kreis 5/6	27	030.7	Spray strip 250mm circuit 5/6	27
030.8	Blasleiste 250mm	27	030.8	Blasting strip 250mm	27

SPRÜHTECHNIK – PRODUKTKATALOG PS16
SPRAY TECHNOLOGY – PRODUCT CATALOG PS16

Artikelgruppe 030 Sprüh-/Blasleisten standard
prod.group 030 spray-/blast strips standard

Pos	Beschreibung	Seite	Pos	description	Page
030.9	Sprühleiste 350mm Kreis 7/8	27	030.9	Spray strip 350mm circuit 7/8	27
030.10	Sprühleiste 250mm Kreis 7/8	27	030.10	Spray strip 250mm circuit 7/8	27
030.11	Sprühleiste 200mm Kreis 5/6	28	030.11	Spray strip 200mm circuit 5/6	28
030.12	Sprühleiste 200mm Kreis 3/4	28	030.12	Spray strip 200mm circuit 3/4	28
030.13	Sprühleiste 200mm Kreis 1/2	28	030.13	Spray strip 200mm circuit 1/2	28
030.14	Blasleiste 200mm	28	030.14	Blasting strip 200mm	28
030.15	Sprühleiste 200mm Kreis 3/4-Kreis 5/6	28	030.15	Spraying strip 200mm circuit 3/4-5/6	28
030.16	Blasleiste 300mm	29	030.16	Blasting strip 300mm	29

Artikelgruppe 035 Blasleiste (23mm)
prod.group 035 blast strips (23mm)

Pos	Beschreibung	Seite	Pos	description	Page
035.1	Verteilerblasleiste 23mm	31	035.1	Distribution blasting strip 23mm	31
035.2	Verteilerblausschliessleiste L	31	035.2	Distribution blasting strip cover left	31
035.3	Verteilerblausschliessleiste R	31	035.3	Distribution blasting strip cover right	31
035.4	Blasleistenmodul 50mm	31	035.4	Blasting strip module 50mm	31
035.5	Blasleistenmodul 100mm	31	035.5	Blasting strip module 100mm	31
035.6	Verteilerblasleiste 23mm	32	035.6	Distribution blasting strip 23mm	32
035.7	Verteilerblasleiste 23mm	32	035.7	Distribution blasting strip 23mm	32
035.8	Verteilerblasleiste 23mm	32	035.8	Distribution blasting strip 23mm	32
035.9	Blasabschlußleiste 50mm links	32	035.9	Left end blasting strip module 50mm	32
035.10	Verteilerblasleiste 23mm	32	035.10	Distribution blasting strip 23mm	32
035.11	Blasleistenumlenkung mit Durchgang	33	035.11	Blasting strip deflection with pass	33
035.12	Blasabschlußleiste 50mm rechts	33	035.12	Right end blasting strip module 50mm	33
035.13	Blasleistendistanzmodul 15mm	33	035.13		33
035.14	Verteilerblasleiste 23mm	33	035.14	Distribution blasting strip 23mm	33
035.15	Verteilerblasleiste 23mm	33	035.15	Distribution blasting strip 23mm	33

Artikelgruppe 040 Sprüh-/Blasleisten Erweit. standard
prod.group 040 spray-/blast strips add. standard

Pos	Beschreibung	Seite	Pos	description	Page
040.1	Sprüh-/Blasleistenmodul 100mm	35	040.1	Spray and blasting strip modul 100mm	35
040.2	Sprüh-/Blasleistenwinkelstück LHA	35	040.2	spray strip angle piece LHA	35
040.3	Sprüh-/Blasleistenwinkelstück LVA	35	040.3	Spray strip angle piece LVA	35
040.4	Sprüh-/Blasleistenwinkelstück RHA	35	040.4	Spray strip angle piece RHA	35
040.5	Sprüh-/Blasleistenwinkelstück RVA	35	040.5	Spray strip angle piece RVA	35

SPRÜHTECHNIK – PRODUKTKATALOG PS16
SPRAY TECHNOLOGY – PRODUCT CATALOG PS16

Artikelgruppe 040 Sprüh-/Blasleisten Erweit. standard
prod.group 040 spray-/blast strips add. standard

Pos	Beschreibung	Seite	Pos	description	Page
040.6	Sprüh-/Blasleistenschliessleiste R	36	040.6	Cover for spray and blasting strip R	36
040.7	Sprüh-/Blasleistenschliessleiste L	36	040.7	Cover for spray and blasting strip L	36
040.8	Sprüh-/Blasleistenmodul 350mm	36	040.8	Spray and blasting strip module 350mm	36
040.9	Sprüh-/Blasleistenwinkelstück LHI	36	040.9	Spray strip angle piece LHI	36
040.10	Sprüh-/Blasleistenwinkelstück RVI	36	040.10	Spray strip angle piece RVI	36
040.11	Sprüh-/Blasleistenwinkelstück LVI	37	040.11	Spray strip angle piece LVI	37
040.12	Sprüh-/Blasleistenmodul 250mm	37	040.12	Spray and blasting strip modul 250mm	37
040.13	Sprüh-/Blasleistenwinkelstück RHI	37	040.13	Spray strip angle piece RHI	37
040.14	Sprüh-/Blasleistenumlenkung RO	37	040.14	Spraying strip extension	37
040.15	Sprüh-/Blasleistendistanzmodul 25mm	37	040.15	Spray and blasting strip spacer modul 25mm	37
040.16	Sprüh-/Blasleistenwinkelstück 45°LVI	38	040.16	Spray strip angle piece 45°LVI	38
040.17	Sprüh-/Blasleistenwinkelstück 45°LHA	38	040.17	Spray strip angle piece 45° LHA	38
040.18	Sprüh-/Blasleistenwinkelstück 45°RVI	38	040.18	Spray strip angle piece 45°RVI	38
040.19	Sprüh-/Blasleistenwinkelstück 45°RHA	38	040.19	Spray strip angle piece 45°RHA	38
040.20	Sprüh-/Blasleistenumlenkung LO	38	040.20	Spraying strip extension	38
040.21	Sprüh-/Blasleistendistanzmodul 100mm	39	040.21	Spray and blasting strip spacer modul 100mm	39
040.22	Sprüh-/Blasleistenmodul 50mm	39	040.22	Spray and blasting strip modul 50mm	39
040.23	Sprüh-/Blasleistenkreuzung	39	040.23	Spray and blasting strip junction	39
040.24	Sprüh-/Blasleisten-Inversmodul m.O-R	39	040.24	Spray and blasting strip inverse module	39
040.25	Sprüh-/Blasleisten-Inversmodul o.O-R	39	040.25	Spray and blasting strip inverse module	39
040.26	Sprüh-/Blasleistenmodul 50mm	40	040.26	Spray and blasting strip	40
040.27	Sprüh-/Blasleistendistanzmodul 50mm	40	040.27	Spray and blasting strip spacer modul 50mm	40
040.28	Sprüh-/Blasleistendistanzmodul 350mm	40	040.28	Spray and blasting strip spacer modul 350mm	40
040.29	Sprüh-/Blasleistendistanzmodul 10mm	40	040.29	Spray and blasting strip spacer modul 10mm	40
040.30	Sprüh-/Blasleisten T-Stück 1	40	040.30	Spray and blasting strip T-piece 1	40
040.31	Sprüh-/Blasleisten T-Stück 2	41	040.31	Spray and blasting T-piece 2	41
040.32	Sprüh-/Blasleistendrehmodul links	41	040.32	Spray and blasting strip twist modul left	41
040.33	Sprüh-/Blasleistendrehmodul rechts	41	040.33	Spray and blasting strip twist modul right	41
040.34	Sprüh-/Blasleistendistanzmodul 15mm	41	040.34	Spray and blasting strip spacer modul 15mm	41
040.35	Sprüh-/Blasabschlußleiste 50mm links	41	040.35	Left end spray and blasting strip module 50mm	41
040.36	Sprüh-/Blasabschlußleiste 50mm rechts	42	040.36	Right end spray and blasting strip module 50mm	42

Artikelgruppe 050 Sprühdüsen außenmisch
prod.group 050 spray nozzles outside mixing

Pos	Beschreibung	Seite	Pos	description	Page
050.1	Sprühdüse SD12	44	050.1	Spray nozzle SD12	44
050.2	Sprühdüse SD13	44	050.2	Spray nozzle SD13	44
050.3	Sprühdüse SD12 Basis	44	050.3	Spray nozzle SD12 carrier	44

SPRÜHTECHNIK – PRODUKTKATALOG PS16
SPRAY TECHNOLOGY – PRODUCT CATALOG PS16

Artikelgruppe 050 Sprühdüsen außenmisch
prod.group 050 spray nozzles outside mixing

Pos	Beschreibung	Seite	Pos	description	Page
050.4	Sprühdüse SD13 Basis	44	050.4	Spray nozzle SD13 carrier	44
050.5	Sprühdüse SD12	44	050.5	Spray nozzle SD12	44
050.6	Sprühdüse SD13	45	050.6	Spray nozzle SD13	45
050.7	Sprühdüse SD13	45	050.7	Spray nozzle SD13	45
050.8	Sprühdüse SD13	45	050.8	Spray nozzle SD13	45
050.9	Sprühdüse SD13	45	050.9	Spray nozzle SD13	45
050.10	Sprühdüse SD12	45	050.10	Spray nozzle SD12	45
050.11	Sprühdüse SD12	46	050.11	Spray nozzle SD12	46
050.12	Sprühdüse SD12	46	050.12	Spray nozzle SD12	46
050.13	Sprühdüse SD12	46	050.13	Spray nozzle SD12	46
050.14	Sprühdüse SD12	46	050.14	Spray nozzle SD12	46
050.15	Sprühdüse SD12	46	050.15	Spray nozzle SD12	46
050.16	Sprühdüse SD12	47	050.16	Spray nozzle SD12	47
050.17	Sprühdüse SD12	47	050.17	Spray nozzle SD12	47
050.18	Sprühdüse SD12	47	050.18	Spray nozzle SD12	47
050.19	Sprühdüse SD12	47	050.19	Spray nozzle SD12	47
050.20	Sprühdüse SD12	47	050.20	Spray nozzle SD12	47
050.21	Sprühdüse SD12	48	050.21	Spray nozzle SD12	48
050.22	Sprühdüse SD12	48	050.22	Spray nozzle SD12	48
050.23	Sprühdüse SD12	48	050.23	Spray nozzle SD12	48
050.24	Sprühdüse SD12	48	050.24	Spray nozzle SD12	48
050.25	Sprühdüse SD12	48	050.25	Spray nozzle SD12	48
050.26	Sprühdüse SD12	49	050.26	Spray nozzle SD12	49
050.27	Sprühdüse SD12	49	050.27	Spray nozzle SD12	49
050.28	Sprühdüse SD13	49	050.28	Spray nozzle SD13	49
050.29	Sprühdüse SD13	49	050.29	Spray nozzle SD13	49
050.30	Sprühdüse SD13	49	050.30	Spray nozzle SD13	49
050.31	Sprühdüse SD13	50	050.31	Spray nozzle SD13	50
050.32	Sprühdüse SD12	50	050.32	Spray nozzle SD12	50
050.33	Sprühdüse SD12	50	050.33	Spray nozzle SD12	50
050.34	Sprühdüse SD12	50	050.34	Spray nozzle SD12	50
050.35	Sprühdüse SD12	50	050.35	Spray nozzle SD12	50
050.36	Sprühdüse SD12	51	050.36	Spray nozzle SD12	51
050.37	Sprühdüse SD12	51	050.37	Spray nozzle SD12	51
050.38	Sprühdüse SD12	51	050.38	Spray nozzle SD12	51
050.39	Sprühdüse SD12	51	050.39	Spray nozzle SD12	51
050.40	Sprühdüse SD12	51	050.40	Spray nozzle SD12	51
050.41	Sprühdüse SD12	52	050.41	Spray nozzle SD12	52
050.42	Sprühdüse SD12	52	050.42	Spray nozzle SD12	52
050.43	Sprühdüse SD12	52	050.43	Spray nozzle SD12	52

SPRÜHTECHNIK – PRODUKTKATALOG PS16
SPRAY TECHNOLOGY – PRODUCT CATALOG PS16

Artikelgruppe 050 Sprühdüsen außenmisch
prod.group 050 spray nozzles outside mixing

Pos	Beschreibung	Seite	Pos	description	Page
050.44	Sprühdüse SD12	52	050.44	Spray nozzle SD12	52
050.45	Sprühdüse SD12	52	050.45	Spray nozzle SD12	52
050.46	Sprühdüse SD12	53	050.46	Spray nozzle SD12	53
050.47	Sprühdüse SD12	53	050.47	Spray nozzle SD12	53
050.48	Sprühdüse SD12	53	050.48	Spray nozzle SD12	53
050.49	Sprühdüse SD12	53	050.49	Spray nozzle SD12	53
050.50	Sprühdüse SD12	53	050.50	Spray nozzle SD12	53
050.51	Sprühdüse SD12	54	050.51	Spray nozzle SD12	54
050.52	Sprühdüse SD12	54	050.52	Spray nozzle SD12	54
050.53	Sprühdüse SD12	54	050.53	Spray nozzle SD12	54
050.54	Sprühdüse SD12	54	050.54	Spray nozzle SD12	54
050.55	Sprühdüse SD13	54	050.55	Spray nozzle SD13	54

Artikelgruppe 060 Sprühdüsen innenmisch
prod.group 060 spray nozzles inside mixing

Pos	Beschreibung	Seite	Pos	description	Page
060.1	Sprühdüse SD3	56	060.1	Spray nozzle SD3	56
060.2	Sprühdüse SD2	56	060.2	Spray nozzle SD2	56
060.3	Sprühdüse SD2 Basis	56	060.3	Spray nozzle SD2 carrier	56
060.4	Sprühdüse SD3 Basis	56	060.4	Spray nozzle SD3 carrier	56
060.5	Sprühdüse SD3	56	060.5	Spray nozzle SD3	56
060.6	Sprühdüse SD3	57	060.6	Spray nozzle SD3	57
060.7	Sprühdüse SD2	57	060.7	Spray nozzle SD2	57
060.8	Sprühdüse SD2	57	060.8	Spray nozzle SD2	57
060.9	Sprühdüse SD2	57	060.9	Spray nozzle SD2	57
060.10	Sprühdüse SD2	57	060.10	Spray nozzle SD2	57
060.11	Sprühdüse SD2	58	060.11	Spray nozzle SD2	58
060.12	Sprühdüse SD2	58	060.12	Spray nozzle SD2	58
060.13	Sprühdüse SD2	58	060.13	Spray nozzle SD2	58
060.14	Sprühdüse SD2	58	060.14	Spray nozzle SD2	58
060.15	Sprühdüse SD2	58	060.15	Spray nozzle SD2	58
060.16	Sprühdüse SD2	59	060.16	Spray nozzle SD2	59
060.17	Sprühdüse SD2	59	060.17	Spray nozzle SD2	59
060.18	Sprühdüse SD2	59	060.18	Spray nozzle SD2	59
060.19	Sprühdüse SD2	59	060.19	Spray nozzle SD2	59
060.20	Sprühdüse SD2	59	060.20	Spray nozzle SD2	59
060.21	Sprühdüse SD2	60	060.21	Spray nozzle SD2	60
060.22	Sprühdüse SD2	60	060.22	Spray nozzle SD2	60

SPRÜHTECHNIK – PRODUKTKATALOG PS16
SPRAY TECHNOLOGY – PRODUCT CATALOG PS16

Artikelgruppe 060 Sprühdüsen innenmisch
prod.group 060 spray nozzles inside mixing

Pos	Beschreibung	Seite	Pos	description	Page
060.23	Sprühdüse SD2	60	060.23	Spray nozzle SD2	60
060.24	Sprühdüse SD2	60	060.24	Spray nozzle SD2	60
060.25	Sprühdüse SD2	60	060.25	Spray nozzle SD2	60
060.26	Sprühdüse SD2	61	060.26	Spray nozzle SD2	61
060.27	Sprühdüse SD2	61	060.27	Spray nozzle SD2	61
060.28	Sprühdüse SD2	61	060.28	Spray nozzle SD2	61
060.29	Sprühdüse SD2	61	060.29	Spray nozzle SD2	61
060.30	Sprühdüse SD2	61	060.30	Spray nozzle SD2	61

Artikelgruppe 070 Blasdüsen
prod.group 070 blast nozzles

Pos	Beschreibung	Seite	Pos	description	Page
070.1	Blas-Set mit KD-I-26	63	070.1	Blasting set with KD-I-26	63

Artikelgruppe 080 ECO-Spray Düsen
prod.group 080 ECO-spray nozzles

Pos	Beschreibung	Seite	Pos	description	Page
080.1	Dosierdüse	65	080.1	Dosing nozzle	65
080.2	Dosierdüse Basis	65	080.2	dosing nozzle carrier	65
080.3	Dosierdüse	65	080.3	Dosing nozzle	65
080.4	Dosierdüse Basis	65	080.4	dosing nozzle carrier	65
080.5	Dosierdüse	65	080.5	Dosing nozzle	65
080.6	Dosierdüse Basis	66	080.6	dosing nozzle carrier	66
080.7	Dosierdüse	66	080.7	Dosing nozzle	66
080.8	Dosierdüse	66	080.8	Dosing nozzle	66
080.9	Dosierdüse Basis	66	080.9	Dosing nozzle carrier	66
080.10	Dosierdüse	66	080.10	Dosing nozzle	66
080.11	Dosierdüse	67	080.11	Dosing nozzle	67
080.12	Dosierdüse Basis	67	080.12	Dosing nozzle carrier	67
080.13	Kappe mit Festanschlag 1	67	080.13	Cap with fixed stop 1	67
080.14	Kappe mit Festanschlag 2	67	080.14	Cap with fixed stop 2	67
080.15	Kappe mit Festanschlag 3	67	080.15	Cap with fixed stop 3	67
080.16	Kappe mit Festanschlag 4	68	080.16	Cap with fixed stop 4	68
080.17	Kappe mit Festanschlag 5	68	080.17	Cap with fixed stop 5	68
080.18	Kappe mit Festanschlag 6	68	080.18	Cap with fixed stop 6	68
080.19	Dosierdüse Basis	68	080.19	Dosing nozzle carrier	68

SPRÜHTECHNIK – PRODUKTKATALOG PS16
SPRAY TECHNOLOGY – PRODUCT CATALOG PS16

Artikelgruppe 080 ECO-Spray Düsen
prod.group 080 ECO-spray nozzles

Pos	Beschreibung	Seite	Pos	description	Page
080.20	Sprühdüse FSD	68	080.20	Spray nozzle FSD	68
080.21	Sprühdüse FSD	69	080.21	Spray nozzle FSD	69
080.22	Sprühdüse FSD Basis	69	080.22	Spray nozzle FSD basis	69
080.23	Sprühdüse FSD	69	080.23	Spray nozzle FSD	69

Artikelgruppe 090 Zubehör außenmisch
prod.group 090 addons outside mixing

Pos	Beschreibung	Seite	Pos	description	Page
090.1	Rohr	71	090.1	Tube	71
090.2	Rohr	71	090.2	Tube	71
090.3	Rohr	71	090.3	Tube	71
090.4	Rohr	71	090.4	Tube	71
090.5	Rohr	71	090.5	Tube	71
090.6	Rohrenddüse	72	090.6	Nozzle for tube	72
090.7	Rohrenddüse	72	090.7	Nozzle for tube	72
090.8	Rohrenddüse	72	090.8	Nozzle for tube	72
090.9	Verschluss für Sprühhrohr AM	72	090.9	blind plug	72
090.10	Umlenkung 90°	72	090.10	Direction change 90°	72
090.11	T-Umlenkung	73	090.11	T-direction change	73
090.12	L-Umlenkung	73	090.12	L-direction change	73
090.13	Rohrenddüse	73	090.13	Nozzle for tube	73

Artikelgruppe 091 Zubehör außenmisch/ECO-Spray
prod.group 091 addons outside mixing/ECO-spray

Pos	Beschreibung	Seite	Pos	description	Page
091.1	Kugeldüse	75	091.1	Ball nozzle	75
091.2	Kugeldüse	75	091.2	Ball nozzle	75
091.3	Kugeldüse	75	091.3	Ball nozzle	75
091.4	Kugeldüse	75	091.4	Ball nozzle	75
091.5	Kugeldüse	75	091.5	Ball nozzle	75
091.6	Kugeldüse	76	091.6	Ball nozzle	76
091.7	Kugeldüse	76	091.7	Ball nozzle	76
091.8	Kugeldüse	76	091.8	Ball nozzle	76
091.9	Kugeldüse	76	091.9	Ball nozzle	76
091.10	Kugeldüse	76	091.10	Ball nozzle	76
091.11	Kugeldüse	77	091.11	Ball nozzle	77

SPRÜHTECHNIK – PRODUKTKATALOG PS16
SPRAY TECHNOLOGY – PRODUCT CATALOG PS16

Artikelgruppe 092 Zubehör innenmisch/blasen
prod.group 092 addons inside/blast mixing

Pos	Beschreibung	Seite	Pos	description	Page
092.1	Kugeldüse	79	092.1	Ball nozzle	79
092.2	Rohr	79	092.2	Tube	79
092.3	Rohr	79	092.3	Tube	79
092.4	Rohrenddüse	79	092.4	Nozzle for tube	79
092.5	Rohrenddüse	79	092.5	Nozzle for tube	79
092.6	Rohr	80	092.6	Tube	80
092.7	Rohr	80	092.7	Tube	80
092.8	Rohr	80	092.8	Tube	80
092.9	Kugeldüse	80	092.9	Ball nozzle	80
092.10	Rohrenddüse	80	092.10	Nozzle for tube	80
092.11	Rohr	81	092.11	Tube	81
092.12	Kugeldüse	81	092.12	Ball nozzle	81
092.13	Kugeldüse	81	092.13	Ball nozzle	81
092.14	Kugeldüse	81	092.14	Ball nozzle	81
092.15	Rohr	81	092.15	Tube	81
092.16	Rohr	82	092.16	Tube	82
092.17	Rohr	82	092.17	Tube	82
092.18	Rohr	82	092.18	Tube	82
092.19	Rohr	82	092.19	Tube	82
092.20	Rohr	82	092.20	Tube	82
092.21	Umlenkung 90°	83	092.21	Direction change 90°	83
092.22	Kugeldüse	83	092.22	Ballnozzle	83
092.23	Kugeldüse	83	092.23	Ballnozzle	83
092.24	Kugeldüse	83	092.24	Ball nozzle	83
092.25	Kugeldüse	83	092.25	Ball nozzle	83
092.26	Rohrenddüse	84	092.26	Nozzle for tube	84
092.27	Rohrenddüse	84	092.27	Nozzle for tube	84
092.28	Rohrenddüse	84	092.28	Nozzle for tube	84
092.29	Rohrenddüse	84	092.29	Nozzle for tube	84
092.30	Rohrenddüse	84	092.30	Nozzle for tube	84

Artikelgruppe 093 Zubehör blasen
prod.group 093 addons blast

Pos	Beschreibung	Seite	Pos	description	Page
093.1	Halteplatte für Rohr auf Blasleiste	86	093.1	Holding plate for tube	86

SPRÜHTECHNIK – PRODUKTKATALOG PS16
SPRAY TECHNOLOGY – PRODUCT CATALOG PS16

Artikelgruppe 093 Zubehör blasen
prod.group 093 addons blast

Pos	Beschreibung	Seite	Pos	description	Page
093.2	Rückschlagventil für Blasset	86	093.2	check valve for blast. set	86

Artikelgruppe 094 Zubehör außenmisch/innenmisch
prod.group 094 addons outside/inside mixing

Pos	Beschreibung	Seite	Pos	description	Page
094.1	Dosierblende	88	094.1	Dosing insert	88
094.2	Dosierblende	88	094.2	Dosing insert	88
094.3	Dosierblende	88	094.3	Dosing insert	88
094.4	Dosierblende	88	094.4	Dosing insert	88
094.5	Dosierblende	88	094.5	Dosing insert	88
094.6	Dosierblende	89	094.6	Dosing insert	89
094.7	Dosierblende	89	094.7	Dosing insert	89
094.8	Dosierblende	89	094.8	Dosing insert	89
094.9	Dosierblende	89	094.9	Dosing insert	89
094.10	Dosierblende	89	094.10	Dosing insert	89

Artikelgruppe 095 Zubehör außen-/innenmisch/blasen
prod.group 095 addons outside/inside mixing blast

Pos	Beschreibung	Seite	Pos	description	Page
095.1	Verschuß (Blindplatte Sprüh-/Blasdüse)	91	095.1	Cover plate	91
095.2	Klemmdeckel für Kugeldüse	91	095.2	Clamp plate for ball nozzle	91
095.3	Halteplatte für Rohr	91	095.3	Holding plate for tube	91
095.4	Sprüh-/Blasdüsenerhöhung 50mm	91	095.4	Spray and blasting nozzle extension 50mm	91
095.5	Sprüh-/Blasdüsenerhöhung, schwenkbar	91	095.5	Rotatable spray and blasting nozzle extension	91
095.6	Sprüh-/Blasdüsenerhöhung 100mm	92	095.6	Spray and blasting nozzle extension 100mm	92
095.7	Sprüh-/Blasdüsenerhöhung 45° links	92	095.7	Spray and blasting nozzle extension 45° left	92
095.8	Sprüh-/Blasdüsenerhöhung 45° rechts	92	095.8	Spray and blasting nozzle extension 45° right	92
095.9	Sprüh-/Blasdüsenerhöhung 45° oben	92	095.9	Spray and blasting nozzle extension 45° above	92
095.10	Sprüh-/Blasdüsenerhöhung 45° unten	92	095.10	Spray and blasting nozzle extension 45° down	92

Artikelgruppe 097 Zubehör ECO-Spray
prod.group 097 addons ECO-spray

Pos	Beschreibung	Seite	Pos	description	Page
097.1	Halteplatte für Rohr	94	097.1	Holding plate	94

SPRÜHTECHNIK – PRODUKTKATALOG PS16
SPRAY TECHNOLOGY – PRODUCT CATALOG PS16

Artikelgruppe 097 Zubehör ECO-Spray
prod.group 097 addons ECO-spray

Pos	Beschreibung	Seite	Pos	description	Page
097.2	Klemmdeckel für Kugeldüse	94	097.2	Clamp plate for ball nozzle	94

Artikelgruppe 100 Sonderteile
prod.group 100 special parts

Pos	Beschreibung	Seite	Pos	description	Page
100.1	Adaptermodul 50mm	96	100.1	Adaptor module 50mm	96
100.2	Sprühleiste 250mm Kreis 5/6	96	100.2	Spray strip 250mm circuit 5/6	96
100.3	Sprüh-/Blasleistenmodul 100mm	96	100.3	Spray and blasting strip module 100mm	96
100.4	Sprüh-/Blasleistenmodul 50mm	96	100.4	Spray and blasting strip module 50mm	96
100.5	Sprühleiste 350mm Kreis 3/4	96	100.5	Spray strip 350mm circuit 3/4	96
100.6	Sprüh-/Blasleistenschliessleiste L	97	100.6	Cover for spray and blasting strip L	97
100.7	Sprüh-/Blasdüsenerhöhung 100mm	97	100.7	Spray and blasting nozzle extension 100mm	97
100.8	Sprüh-/Blasabschlußleiste 100mm links	97	100.8	Left end spray and blasting strip module 100mm	97
100.9	Sprüh-/Blasdüsenerhöhung 50mm	97	100.9	Spray and blasting nozzle extension 50mm	97
100.10	Sprüh-/Blasdüsenerhöhung 45° oben	97	100.10	Spray and blasting nozzle extension 45° above	97
100.11	Sprühleiste 350mm Kreis 1/2	98	100.11	Spray strip 350mm circuit 1/2	98
100.12	Sprüh-/Blasleistenschliessleiste R	98	100.12	Cover for spray and blasting strip R	98
100.13	Sprüh-/Blasdüsenerhöhung 45° unten	98	100.13	Spray and blasting nozzle extension 45° down	98
100.14	Sprühdüse SD13	98	100.14	Spray nozzle SD13	98
100.15	Verteilerschließplatte O	98	100.15	Endplate upside	98
100.16	Adaptermodul 25mm	99	100.16	Adaptor module 25mm	99
100.17	Sprüh-/Blasdüsenerhöhung 45° links	99	100.17	Spray and blasting nozzle extension 45° left	99
100.18	Sprüh-/Blasdüsenerhöhung 45° rechts	99	100.18	Spray and blasting nozzle extension 45° right	99
100.19	Verteilerschließplatte U	99	100.19	Distributor cover below	99

Artikelgruppe 110 Handling, Versteifung, etc.
prod.group 110 handling / strenghtening / etc

Pos	Beschreibung	Seite	Pos	description	Page
110.1	Verstärkungsleiste	101	110.1	Reinforcing strip	101
110.2	Verstärkungsleiste	101	110.2	Reinforcing strip	101
110.3	Verstärkungsleiste	101	110.3	Reinforcing strip	101
110.4	Verstärkungsleiste	101	110.4	Reinforcing strip	101
110.5	Verstärkungsleiste	101	110.5	Reinforcing strip	101
110.6	Befestigungsleiste	102	110.6	attachment strip	102
110.7	Befestigungsleiste	102	110.7	attachment strip	102
110.8	Verstärkungsleiste	102	110.8	Reinforcing strip	102

SPRÜHTECHNIK – PRODUKTKATALOG PS16
SPRAY TECHNOLOGY – PRODUCT CATALOG PS16

Artikelgruppe 110 Handling, Versteifung, etc.
prod.group 110 handling / strengthening / etc

Pos	Beschreibung	Seite	Pos	description	Page
110.9	Befestigungsleiste	102	110.9	attachment strip	102
110.10	Verstärkungsleiste	102	110.10	Reinforcing strip	102
110.11	Verstärkungsleiste	103	110.11	Reinforcing strip	103
110.12	Befestigungsleiste	103	110.12	attachment strip	103
110.13	Verstärkungsleiste	103	110.13	Reinforcing strip	103
110.14	Verstärkungsleiste	103	110.14	Reinforcing strip	103

Artikelgruppe 120 Zubehör
prod.group 120 addons

Pos	Beschreibung	Seite	Pos	description	Page
120.1	Ringschraube C15E M12 DIN580	105	120.1	eye bolt C15E M12 DIN580	105
120.2	Düsenjustiergerät	105	120.2	Nozzle adjustment unit	105
120.3	Flachstange 20x5mm	105	120.3	flat bar 20x5mm	105
120.4	Befestigungsklotz	105	120.4	chock	105
120.5	Querleiste	105	120.5	Cross strip for lift the tool	105
120.6	Befestigungsklotz	106	120.6	chock	106
120.7	Querleiste	106	120.7	Cross strip for lift the tool	106
120.8	Leiste	106	120.8	Strip	106
120.9	Leiste	106	120.9	Strip for transport rack	106
120.10	Leiste	106	120.10	Strip for transport rack	106
120.11	Leiste	107	120.11	Strip for transport rack	107
120.12	Leiste	107	120.12	Strip	107